

ebmpapst

the engineer's choice

Best under pressure:
*The pressure-resistant
AxiEco Protect axial fan.*

Now as a complete product range.

About ebm-papst.

ebm-papst is a leader in ventilation and drive engineering technology and a much sought-after engineering partner in many industries. With around 20,000 different products, we have the perfect solution for practically every requirement. We have placed the highest emphasis on economy and ecology for many years.

We believe the consistent further development of our highly-efficient GreenTech EC technology provides our customers with the best opportunities for the future in industrial digitization. With GreenIntelligence, ebm-papst already offers intelligent networked complete solutions that are unique anywhere in the world today and that secure our customers a decisive advantage.

The logo for ebm-papst, featuring the company name in a bold, lowercase, sans-serif font. The 'e' and 'p' are in a dark blue color, while the 'b', 'm', 'a', 's', and 't' are in a lighter blue color.

the engineer's choice

Six reasons that make us the ideal partner:

Our systems expertise.

You want the best solution for every project. The entire ventilation system must thus be considered as a whole. And that's what we do – with **motor technology** that sets standards, sophisticated **electronics** and **aerodynamic** designs – all from a single source and perfectly matched.

Our spirit of invention.

We are also always able to develop customized solutions for you with our versatile team of over 600 engineers and technicians.

Our lead in technology.

We are not only pioneers and trailblazers in the development of highly efficient EC technology, we also recognized the opportunities of digitization at an early stage. Therefore, we can offer solutions today that combine the highest energy efficiency with the advantages of IoT and digital networking.

Closeness to our customers.

ebm-papst has 25 production locations worldwide (including facilities in Germany, China and the USA), together with 49 sales offices, each of which has a dense network of sales representatives. You will always have a local contact, someone who speaks your language and knows your market.

Our standard of quality.

Our quality management is uncompromising, at every step in every process. This is underscored by our certification according to international standards including DIN EN ISO 9001, TS declaration of conformity and DIN EN ISO 14001.

Our sustainable approach.

Assuming responsibility for the environment, for our employees and for society is an integral part of our corporate philosophy. We develop products with an eye to maximum environmental compatibility, in particular resource-preserving production methods. We promote environmental awareness among our young staff and are actively involved in sports, culture and education. That's what makes us a leading company – and an ideal partner for you.

Top form under pressure: *the new AxiEco Protect.*

Refrigeration, ventilation, air conditioning and mechanical engineering are accompanied by tough ambient conditions. If you want to cope with them effectively, you need electrically and mechanically robust solutions that also work at a high level of efficiency. AC axial fans that have been widely used up until now will reach their limits in this contentious area by the time the next stage of the ErP comes into force. Or maybe not.

With the AxiEco Protect, ebm-papst has been able to develop an axial fan that is perfectly tailored to the requirements of evaporators, condensers, air heaters, heat pumps, control cabinet and generator cooling systems, as well as numerous other applications.

It makes a great impression with its robustness, high performance, low noise levels and economical operation both in its EC and AC design.

Its hallmark: The new axial fan is BEST UNDER PRESSURE. This essentially means that when it is under significant pressure, it really shows what it can do. It is especially effective in fighting against high back pressures in ventilation, air conditioning and refrigeration applications: it is durable, highly efficient and quiet.

What exactly does that mean for individual sectors and applications? Take it from us:

It withstands pressure and ice formation like no other: the AxiEco Protect in refrigeration technology.



A great strength of the AxiEco Protect can be seen in evaporator applications, for example. If ice forms on the heat exchanger, the AxiEco Protect works with high efficiency for longer despite the increasing back pressure. The reason for this is its improved aerodynamics, which has a much steeper characteristic curve than usual, resulting in an extended evaporator service life, fewer defrosting cycles and better efficiency of the overall system. In addition, its innovative design means that the guard grill freezes more slowly and the blades do not freeze on the fan housing.

Conquering new power ranges: the AxiEco Protect in ventilation and air conditioning technology.



Thanks to its aerodynamic optimizations, the air performance curve of the AxiEco Protect is much steeper than that of comparable axial fans, meaning that it covers a significantly larger power range. Therefore, it still works at optimum efficiency even when the back pressure is increasing. It is very advantageous for use in ventilation and air conditioning technology: from now on, fewer fans are required to generate the same output. The reason for this is the power density: the AxiEco Protect achieves a higher air performance per area. Despite its powerful performance, the AxiEco Protect is extremely quiet, which is apt for heat pumps in residential areas, for example.

Top performance in extremely confined spaces: the AxiEco Protect in mechanical engineering.



Thanks to a variety of design details, the new AxiEco Protect is also ideally adapted to various areas of application within mechanical engineering. In control cabinet construction, for example, the ErP-compliant axial fan also boasts an increased air performance, enabling manufacturers to reduce the total number of devices used. In all its sizes, the AxiEco Protect impresses with its compact design, which can become a decisive competitive advantage considering the confined spaces seen in electronics and compressor cooling systems.

Perfect protection against *environmental influences.*

The new AxiEco Protect completely embodies its second name. Thanks to its robust design, the compact axial fan in the basket guard grill is optimally protected against environmental influences such as humidity. It can easily generate the pressures required in refrigeration, ventilation, air conditioning and mechanical engineering.

Clever design details ensure optimized impeller geometry and high efficiency, guaranteeing consistent protection against unnecessary energy consumption. As is usual at ebm-papst, it is quick and easy to install using plug & play.

Impeller with improved geometry

In accordance with the latest findings in aerodynamics, the blade shape has undergone three-dimensional improvements and the impeller has been optimized.

Robust guard grill

The fan guard grill is made of metal, making it very robust.

No tip gap

In the AxiEco Protect, there is no longer any tip gap between the fan housing and the impeller. The impeller, integrated diffuser ring and hub form a compact unit and the blade tips seamlessly join the oil slinger. This brings two advantages: Firstly, there is no flow over the blade tips. This increases efficiency and reduces noise. Secondly, the blades can no longer freeze on the nozzle.

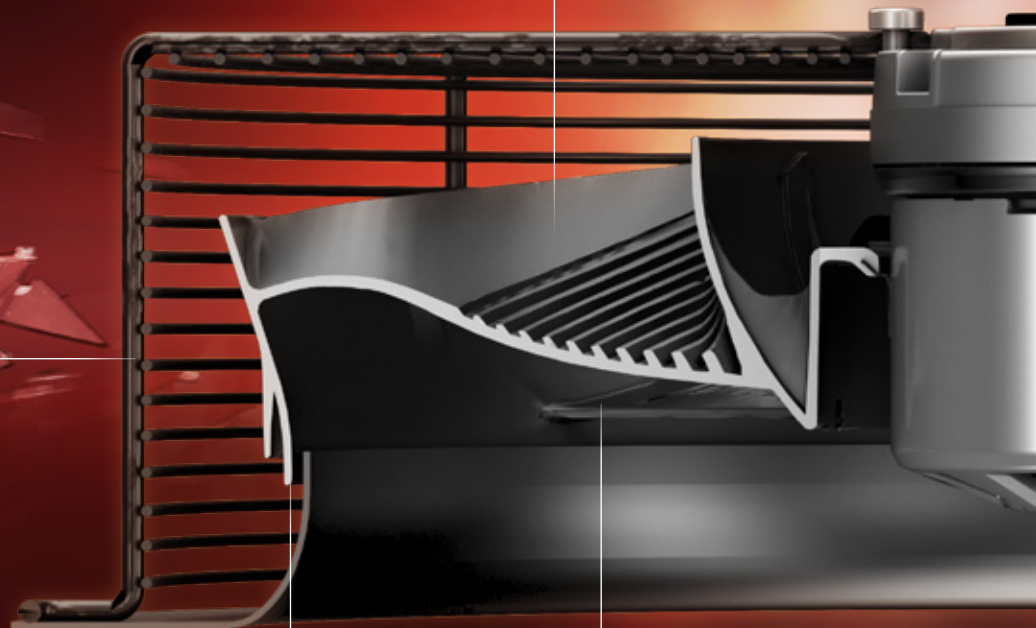



1. Activate the module

Go into the ebm-papst Xplore app and select the AxiEco module.

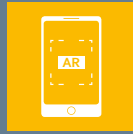

2. Scan the images

Aim the camera at the images marked with this icon, and away you go.

Diffuser with increasing pressure

The integrated diffuser ring of the AxiEco Protect also performs the function of a diffuser. This means that it is integrated directly into the impeller, which has a larger outflow angle than other axial fans. As it makes the pressure increase, the diffuser reduces outlet losses, meaning that it contributes to noise reduction.

Grooved blades

The fan blades of the AxiEco Protect have grooves. This increases its mechanical stability, in turn enabling a higher power density.



Questions and answers *about the AxiEco Protect.*



What makes the outflow characteristic of the AxiEco Protect so special?

The AxiEco Protect is characterized by its improved flow profile, among other things. This is best shown when comparing it to the flow profile of a common axial fan:

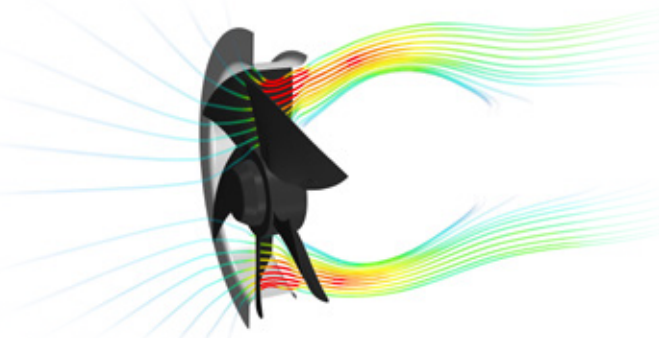

Existing solution: HyBlade

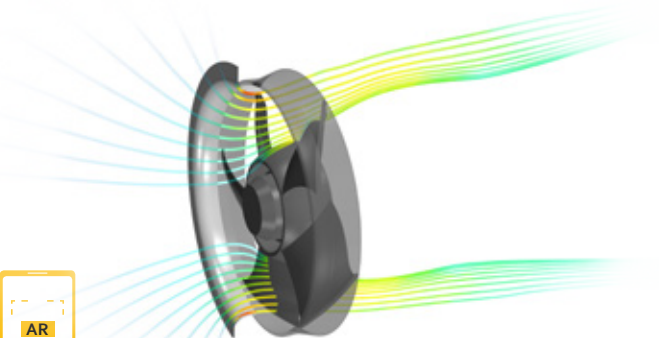

New solution: AxiEco Protect

while the air flow of other axial fans spreads outwards, the outflow characteristic of the AxiEco Protect remains “on course”, even when there are higher back pressures, and retains the axial direction. The flow direction remains constant and the air in the interior is therefore not taken in again.



How does the AxiEco Protect fight off ice formation?

Ice formation particularly afflicts evaporators if the humidity precipitates on the heat exchanger as ice at cold ambient temperatures. This means that the air path is restricted and the pressure increases. This is where the AxiEco Protect’s key benefit comes in: at higher back pressures, it offers many more pressure reserves than other fans. This extends the intervals between defrosting cycles and means that the refrigerating plant can be operated more efficiently for longer periods.

Another advantage is its optimized ice formation behavior: The AxiEco Protect has no tip gap, therefore it is unlikely that the impeller freezes up.

Last but not least, its better flow profile delays the formation of ice on the guard grill, because the interior air is not drawn in again but remains in an axial direction.



Why is the AxiEco Protect’s high power density advantageous?

Since the AxiEco Protect can be operated at higher speeds, it achieves a higher air performance per area. Compared to other axial fans, this means that fewer fans are required to deliver the same performance. This not only increases overall efficiency, but also saves space.



How does the AxiEco Protect increase efficiency?

More stringent demands will be placed on the efficiency of fans by the time the next stage of the ErP comes into force. The AxiEco Protect already easily fulfills these criteria: its efficiency ratings are impressive. It boasts an efficiency increase of over 20% compared to the HyBlade with full nozzle (depending on the size).



Why is the AxiEco Protect so incredibly quiet?

The AxiEco Protect is up to 6 dB(A) quieter than the HyBlade (depending on the size). The main reason behind this is that the impeller, integrated diffuser ring and hub of the AxiEco Protect form a compact unit. The blade tips seamlessly join the integrated diffuser ring so there is no longer any tip gap between the fan housing and the impeller. This results in hardly any turbulence in the edge area – and therefore also less noise. The integrated diffuser also helps to reduce noise, meaning that the noise level remains pleasantly low even at higher pressure ranges.

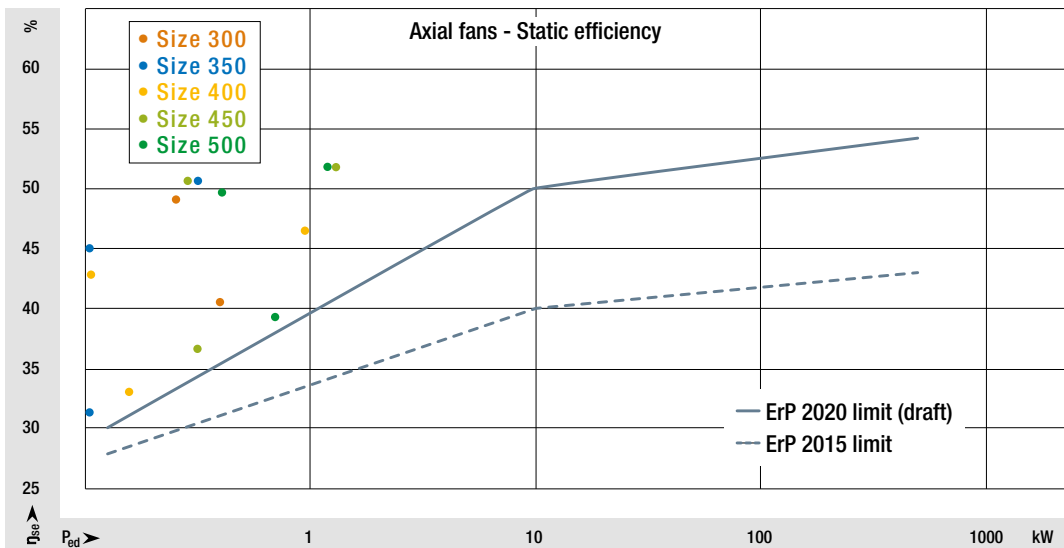

Why is it beneficial to me that the AxiEco Protect conforms to the ErP?

In the next stage of the ErP Directive (Energy-related products directive), the EU is stipulating mandatory minimum efficiency levels for fans. A device will only be able to bear the CE label if it fulfills the required standard values. With the AxiEco Protect, manufacturers are on the safe side and are ideally equipped for the future. The AxiEco Protect fully complies with the new ErP requirements. Its efficiency is considerably better than that of previous axial fans, meaning that it operates much more efficiently.



What are the advantages of using EC motor technology?

The new AxiEco Protect meets the requirements of the next stage of the ErP regardless of the motor technology used, but EC technology offers additional benefits:

- better efficiency than AC motors
- less waste heat and, therefore, lower energy consumption
- demand-based control via a 0 to 10 V signal
- some motor variants can also be controlled via MODBUS-RTU

Starting autumn 2020, the AxiEco family will be expanded with additional features and options, allowing for even more choices for your refrigeration, ventilation, air conditioning and mechanical engineering applications.

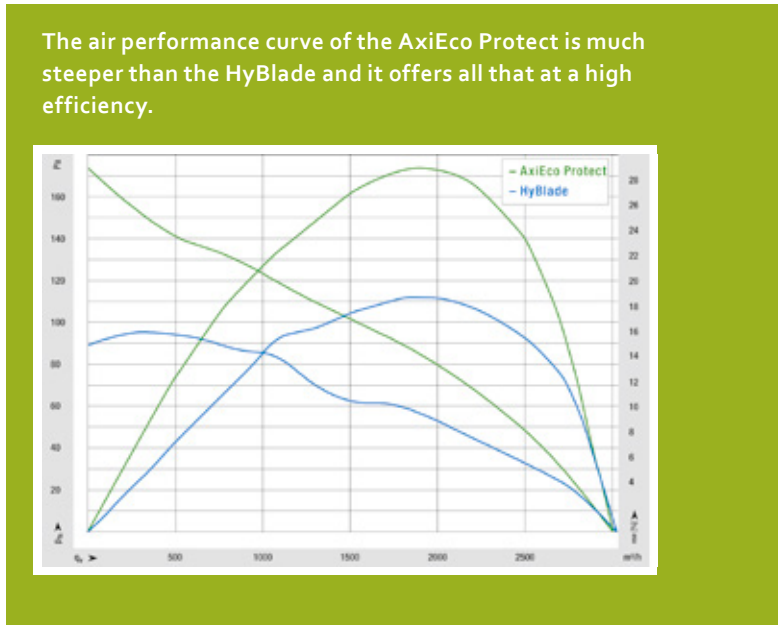

If you have any further questions, you can contact us at any time. Please contact:
 +49 7938 81-0 or info1@de.ebmpapst.com

Performance is reflected in the details.

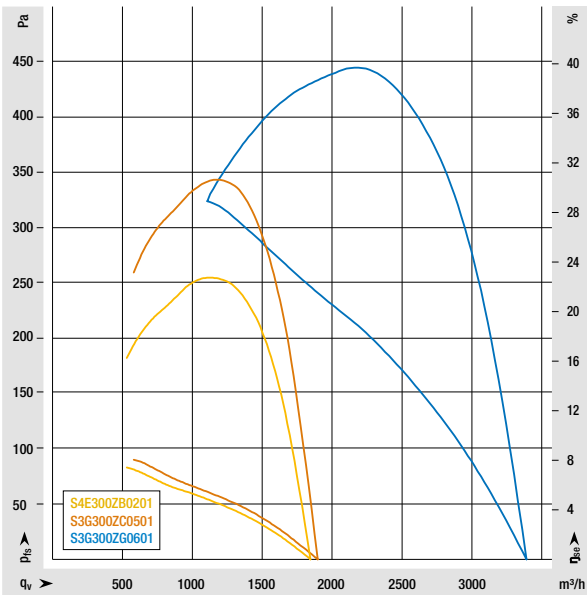

Characteristic curve field for size 300.

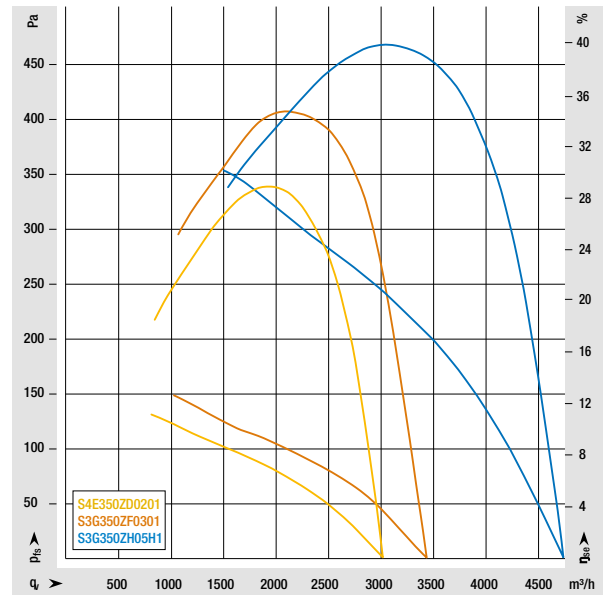

Characteristic curve field for size 350.

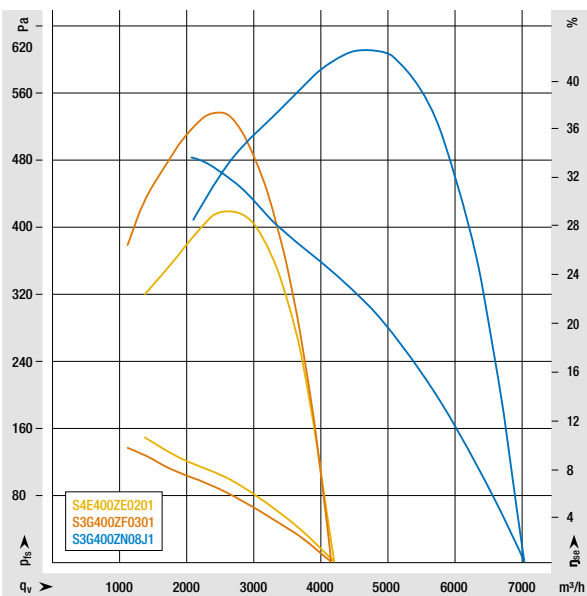

Characteristic curve field for size 400.

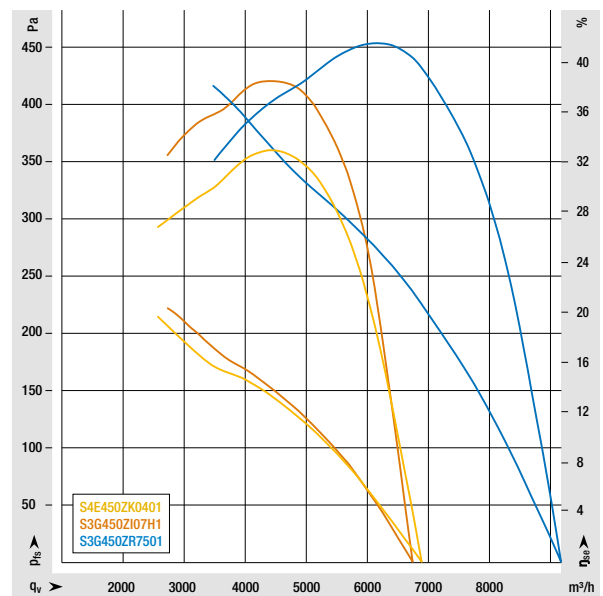

Characteristic curve field for size 450.

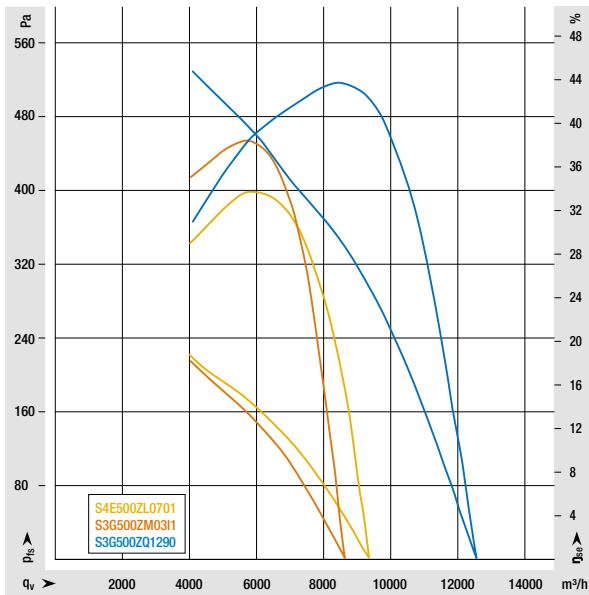

Characteristic curve field for size 500.

Nominal data			Nominal voltage range	Frequency	Speed ⁽¹⁾	Max. power consumption ⁽¹⁾	Max. input current ⁽¹⁾	Permiss. ambient temp. ⁽²⁾
Size	Item number	Motor	V AC	Hz	rpm	W	A	°C
300	S4E300ZB0201	AC	1-230	50/60	1.225/1.200	75/95	0.33/0.42	-25 to +60/55
	S3G300ZC0501	EC	1-200-240	50/60	1.270	65	0.60	-25 to +60
	S3G300ZG0601	EC	1-200-277	50/60	2.400	345	1.52	-25 to +60
350	S4E350ZD0201	AC	1-230	50	1.325	160	0.70	-25 to +60
	S3G350ZF0301	EC	1-200-240	50/60	1.434	170	1.50	-25 to +60
	S3G350ZH05H1	EC	1-200-277	50/60	2.200	500	2.30	-25 to +60
400	S4E400ZE0201	AC	1-230	50	1.300	260	1.20	-25 to +60
	S3G400ZF0301	EC	1-200-240	50/60	1.210	170	1.30	-25 to +60
	S3G400ZN08J1	EC	3-380-480	50/60	2.300	1.010	1.60	-25 to +60
450	S4E450ZK0401	AC	1-230	50	1.385	540	2.50	-25 to +60
	S3G450ZI07H1	EC	1-200-277	50/60	1.390	500	2.20	-25 to +60
	S3G450ZR7501	EC	3-380-480	50/60	1.910	1.200	1.90	-25 to +60
500	S4E500ZL0701	AC	1-230	50	1.300	870	3.90	-25 to +60
	S3G500ZM0311	EC	1-200-277	50/60	1.270	650	2.90	-25 to +60
	S3G500ZQ1290	EC	3-380-480	50/60	1.870	1.950	3.00	-25 to +60

Subject to technical changes.

⁽¹⁾ Nominal data at operating point with maximum load and 230 VAC.

⁽²⁾ Variants up to -40°C for deep freeze applications available on request.

Values are measured with guard grill.

Facts *that can withstand any pressure.*

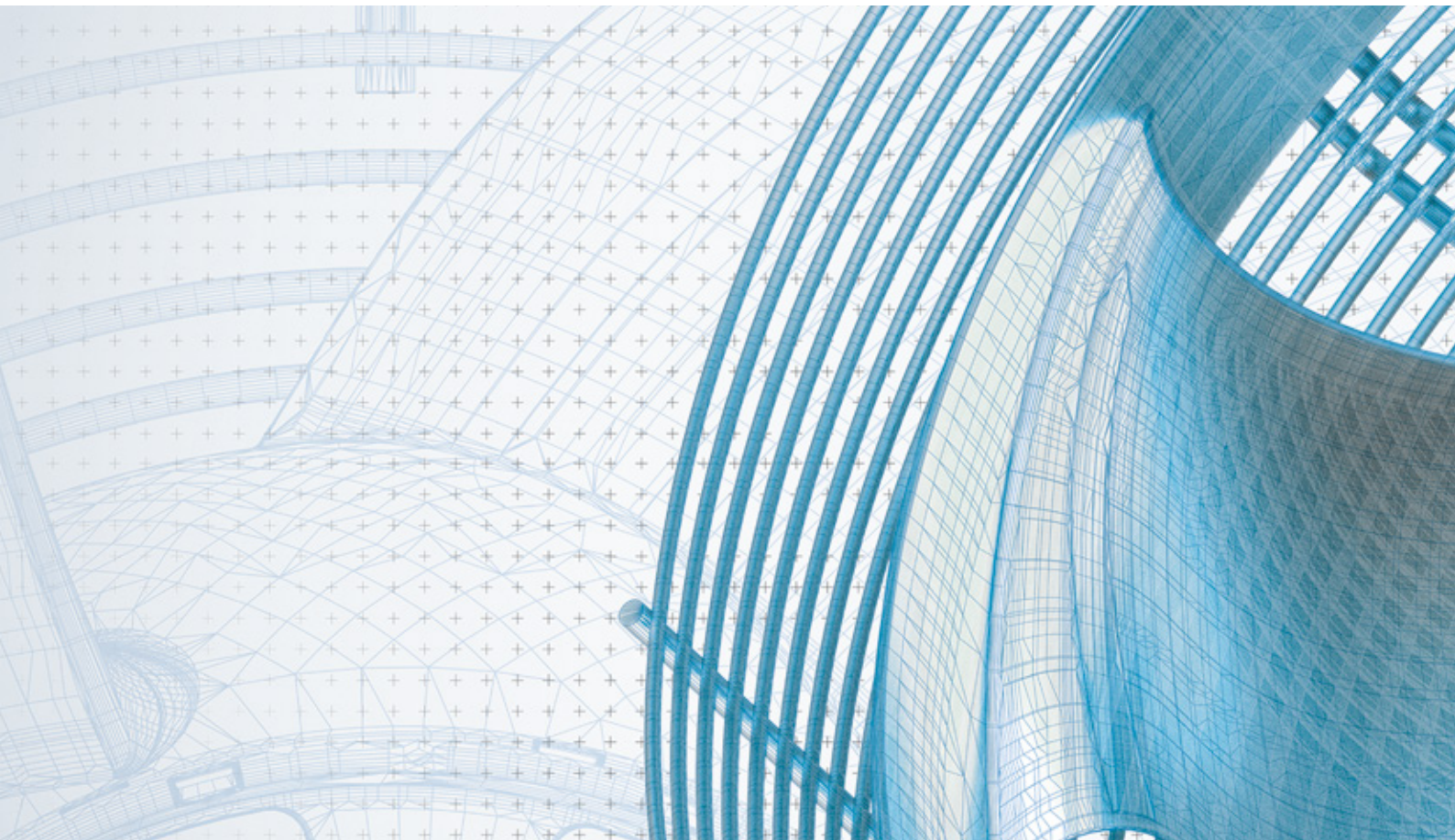
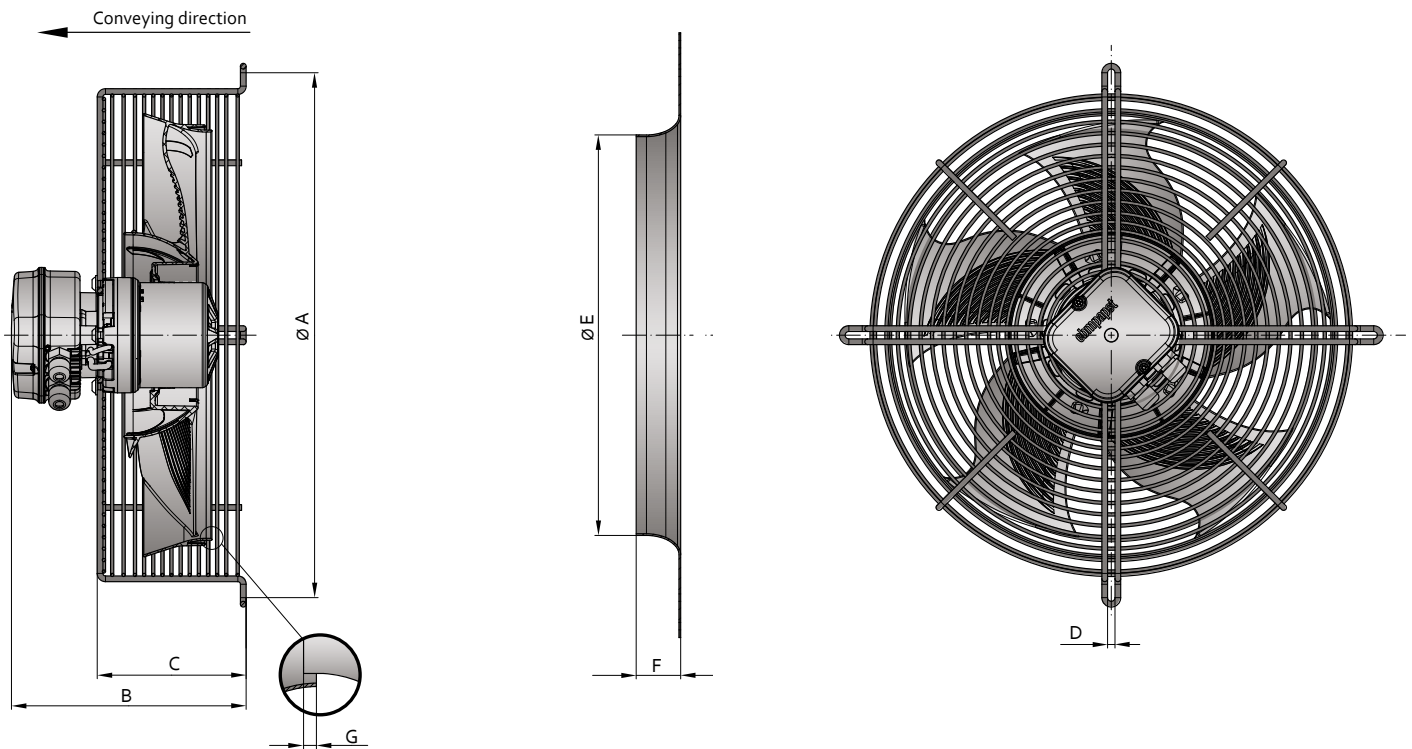

Dimensions			Screw-on diameter	Total height (with terminal box)	Height of grille	Lug diameter	Outer nozzle diameter	Nozzle height	Overlap
Size	Item number	Motor	A	B	C	D	E	F	G
300	S4E300ZB0201	AC	412	180.6	114.5	6.5			
	S3G300ZC0501	EC	412	180.6	114.5	6.5	305.5 _{0/-1.0}	34.0 _{0/-1.0}	6.0
	S3G300ZG0601	EC	412	209.7	121.7	6.5			
350	S4E350ZD0201	AC	460	201.1	130.5	6.5			
	S3G350ZF0301	EC	460	205.7	130.5	6.5	351.0 _{0/-1.5}	39.0 _{0/-1.5}	7.5
	S3G350ZH05H1	EC	460	212.3	124.5	6.5			
400	S4E400ZE0201	AC	513	220.6	149.3	6.5			
	S3G400ZF0301	EC	513	225.2	149.3	6.5	394.5 _{0/-2.0}	42.0 _{0/-2.0}	12.0
	S3G400ZN08J1	EC	513	261.2	156.3	6.5			
450	S4E450ZK0401	AC	581	230.0	170.5	7.0			
	S3G450ZI07H1	EC	581	259.0	174.5	7.0	448.0 _{0/-2.0}	48.8 _{0/-2.0}	12.0
	S3G450ZR7501	EC	581	274.5	180.5	7.0			
500	S4E500ZL0701	AC	649	254.0	195.5	7.0			
	S3G500ZM03I1	EC	649	301.0	199.5	7.0	502.0 _{0/-2.0}	57.0 _{0/-2.0}	14.0
	S3G500ZQ1290	EC	649	274.3	219.0	7.0			

Subject to technical changes. All dimensions in mm. Data sheets available on request.

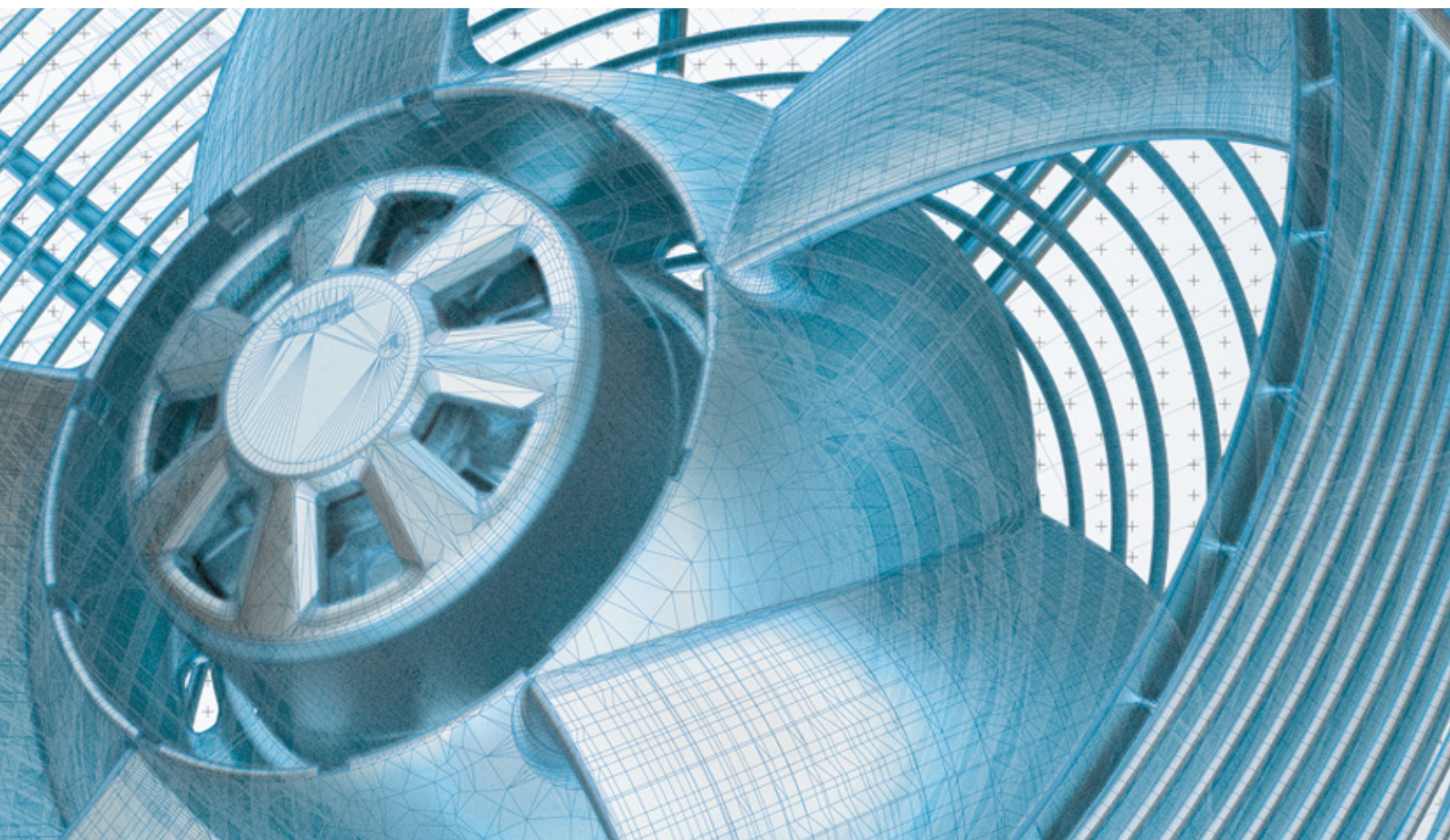

www.ebmpapst.com

ebmpapst

the engineer's choice

ebm-papst
Mulfingen GmbH & Co. KG

Bachmühle 2
74673 Mulfingen
Germany
Phone +49 7938 81-0
Fax +49 7938 81-110
info1@de.ebmpapst.com