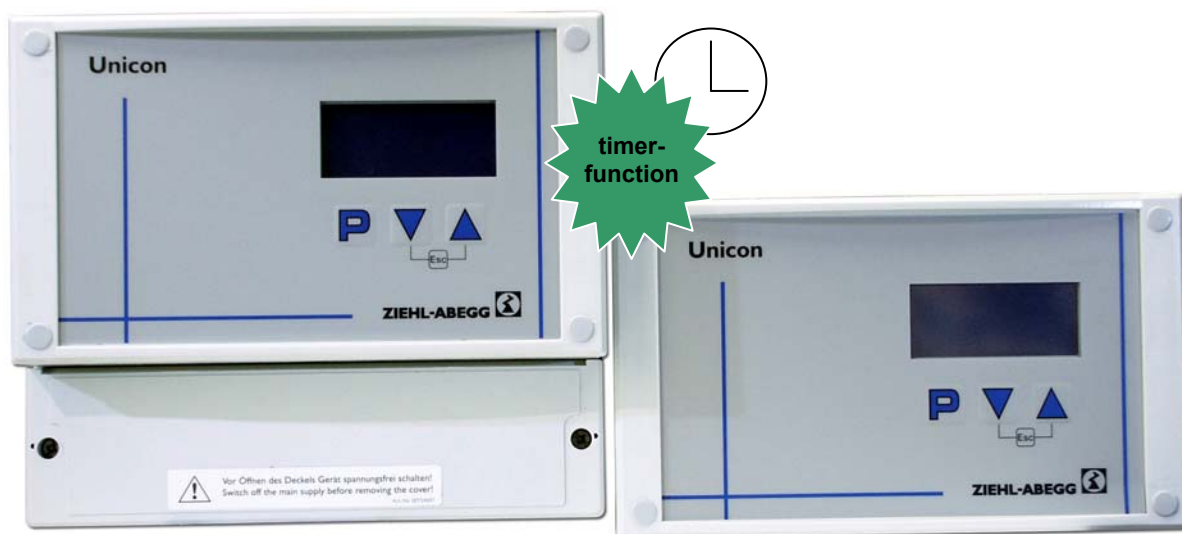


Unicon

Type CXE/AVC (E)

Universal module with timer function



Manufacturer: ZIEHL-ABEGG AG
Heinz-Ziehl-Straße
D-74653 Künzelsau
Telefon: +49 (0) 7940 16-0
Telefax: +49 (0) 7940 16-504
e-mail: info@ziehl-abegg.de
internet: <http://www.ziehl-abegg.de>

Software D 1185A03 Part.No. 00162609 from version 1.07

Contents

1. General..... **4**

2. Safety measures **4**

3. General description **5**

3.1 Scope of applications 5

3.2 Technical data 5

3.3 Versions Unicon 5

4. Installation **6**

4.1 Wall-mounting, installation in a switching cabinet 6

4.2 Outdoor installation 6

4.3 Installation location for agriculture 6

4.4 Temperature influences during commissioning 6

4.5 Potential at control voltage connections 6

5. Electrical connections **7**

5.1 Mains connection 7

5.2 Signal cable (sensor cable) 7

5.3 Signal connection to analog inputs (Analog IN1, Analog IN2, ..) 7

5.4 Output voltage 0-10 V (Analog OUT1 und Analog OUT2) 7

5.5 Voltage supply for external devices (+24 V, GND) 7

5.6 Relay outputs (K1, K2) 7

5.7 Digital inputs (D1 .. D5) 8

5.8 Connection RS-485 interface for MODBUS 8

6. Controls **8**

6.1 Multipurpose LC display 8

7. Connection terminals depending on input signal **9**

7.1 External Setpoint / External speed setting in manual operation 9

8. Mode selection **10**

8.1 Selection of the mode of operation 10

8.2 Menu operation 11

8.3 Setting Mode, menu language and motorsetup 12

9. Programming..... **13**

9.1 Speed controller **1.01** 13

 9.1.1 Basic setting **1.01** 13

 9.1.2 Setting for operation **1.01** 13

 9.1.3 Menu speed controller **1.01** 14

9.2 Temperature control **2.01**.. **2.05** 15

 9.2.1 Basic setting **2.01**.. **2.05** 15

 9.2.2 Settings for operation modes **2.01** .. **2.05** 16

 9.2.3 Functional diagrams temperature control 17

 9.2.4 For mode **2.03** temperature controller with additional functions: Signal output 0-10 V 18

 9.2.6 For mode **2.03** Relay output for temperature monitoring 20

9.3 Pressure control for condensers refrigeration **3.01** .. **3.04** 23

 9.3.1 Basic setting **3.01** **3.02** 23

 9.3.2 Setting for operation **3.01** .. **3.04** 24

 9.3.3 Menu for pressure control refrigeration **3.01** .. **3.04** 25

9.4 Pressure control for ventilation systems **4.01**.. **4.03** 27

 9.4.1 Basic setting **4.01**.. **4.03** 27

 9.4.2 Setting for operation modes **4.01** .. **4.03** 28

 9.4.3 Menu for pressure control airconditioning **4.01** .. **4.02** 29

9.5 Volume control **5.01**, **5.02** 31

 9.5.1 Basic setting **5.01**, **5.02** 31

 9.5.2 Setting for operation modes **5.01** and **5.02** 32

9.6 Air velocity control **6.01** 35

 9.6.1 Basic setting **6.01** 35

 9.6.2 Settings for operation modes **6.01** 35

 9.6.3 Menu for air velocity control **6.01** 36

10. Menu group Start **38**

11. Menu group Info **38**

12. Controller Setup **39**

 12.1 PIN Protection 39

 12.2 Set protection 39

 12.3 Save user settings 39

 12.4 Sensor Alarm ON / OFF 40

 12.5 Limit 40

 12.6 Minimum speed cut off 40

 12.7 Second Group 41

 12.8 Reverse action of the control function (actual Value>Set = n+) 41

 12.9 Controller configuration (controller type) and controller action) 42

13. IO Setup **43**

 13.1 Analog Output A (Analog OUT 1) 43

 13.1.1 Function analog output A (Analog OUT 1) 43

 13.1.2 Adjustment analog output A1 und A2 44

 13.2 Functional overview of digital inputs D1 ... D5 45

 13.2.1 Enable ON / OFF **Funktion 1D** 46

 13.2.2 External fault **Funktion 2D** 46

 13.2.3 Limit ON / OFF **Funktion 3D** 47

 13.2.4 Switch over E1 / E2 **Funktion 4D** 47

 13.2.5 Set Intern 1 / Set Intern 2 or. Setpoint 1/2 **Funktion 5D** 48

 13.2.6 Intern / Extern **Funktion 6D** 49

 13.2.7 Automatic control / speed manual internal (Menu Speed maunal) **Funktion 7D** 50

 13.2.8 Reverse action of control function actual value>Set = n+ or actual value>Set = n- **Funktion 8D** 50

 13.3 Inverting analog inputs E1 and E2 51

 13.4 Function and inverting for relay outputs K1 and K2 52

 13.5 Network for several devices by MODBUS 53

 13.5.1 MODBUS - RTU (Remote terminal unit) 53

 13.5.2 External display 53

 13.5.3 Reading and writing parameters 53

14. Limits **54**

 14.1 Limit indication depending on modulation 54

 14.2 Limit indication depending on setting or sensor signal 55

 14.3 Limit indication depending on offset to Setpoint 56

15. Timer (timer) **57**

 15.1 Setting the time and date 57

 15.2 Automatic summer/winter time 57

 15.3 Timer function 57

 15.4 Enter switching times 58

16. Diagnostics menu **59**

17. Enclosure **60**

 17.1 Connection diagram 60

 17.2 Dimension sheet 61

18. Events **62**

19. Messages and trouble shooting **62**

20. Index **63**

1. General

Before installation and start-up, read this manual carefully to ensure a correct use.

Attention! Hazardous area!



Danger owing to electric current or voltage!!



Important information!



- The copyright for these operating instructions remains to ZIEHL-ABEGG AG, Künzelsau.
- The device is constructed in accordance with the current state of technology and the recognised safety regulations. Nevertheless, use of the device is associated with dangers which may cause death or injury to users or third parties as well as damage to the system and other objects.
- The device is intended exclusively for the tasks listed in the order confirmation. Any other or extraordinary uses of the device (unless previously agreed by contract) are considered contrary to regulations. The manufacturer is not liable for damages resulting from incorrect use. The operating company alone bears the risk.
- To allow for future developments, construction methods and technical data given are subject to alteration. We do not accept any liability for possible errors or omissions in the information contained in data, illustrations or drawings provided.
- The controllers are packed ex factory to suit the transport method previously agreed. Always use the original packaging materials when transporting the controller. When transporting by hand, ensure that personnel possess the strength required to lift and carry the device. Avoid shocks and impacts to the device. Check the packaging and controller for damage.
- Store the controller in its original packaging in a dry and weather-proof room. The device must not be exposed to extreme heat and low temperatures.

2. Safety measures

In the case of a malfunction or a failure of the equipment check all functions with alarms in order to prevent injury to persons or property. Note possibility of back-up operation.

If used in intensive animal environments, any malfunctions in the air supply must be detected as soon as possible to prevent the development of a life-threatening situation for the animals. The design and installation of the system must comply with local regulations and directives. In Germany these include DIN VDE 0100, the animal protection and the keeping of working animals ordinance and the pig-keeping ordinance etc.

Also note the instructions of AEL, DLG, VdS.

- Apart from the operating instructions and the obligatory regulations to be followed by users relating to accident prevention, the recognised technical regulations must also be observed (safety and branch-related work as per UVV, VBG, VDE, etc.).
- These devices are potentially dangerous if they are used incorrectly by untrained personnel or are not implemented according to their specified use.
- **Work on electric components/modules may only be carried out by trained electricians in accordance with electro-technical regulations (e.g. EN 60204, DIN VDE 0100/0113/0160).**
- The contractor or owner must also ensure that the electric systems and equipment are operated and maintained in accordance with electro-technical regulations. The owner is obliged to ensure that the device are operated in perfect working order only.
- **It is forbidden to carry out work on electrically live parts. The rating given in the enclosure for the device when open is IP00! It is possible to inadvertently touch components carrying hazardous voltages!**
- During operation, the device must be closed or installed in a control cabinet.
- Fuses may only be replaced by new ones and must not be repaired or bypassed. The data for the maximum line fuse are to be considered absolutely (☞ Technical data). Use only fuses specified in schematic diagrams.
- The safe isolation from the supply must be checked using a two-pole voltage detector.
- Any faults detected in the electric system/modules/operating equipment must be corrected immediately. If these faults are not corrected, the device/system is potentially very dangerous. The device/system must therefore not be operated when it is faulty.

3. General description

3.1 Scope of applications

Universal controller for clean room, refrigeration and air conditioning

Controlled 0-10 V „A1“ (Analog OUT 1) output e.g. for electronic speed controllers of fans

3.2 Technical data

Type	Part.No	line voltage	internal device fuse	Weight
CXE/AVC	320006	1~ 110 .. 277 V (-15 % bis +10 %), 50/60 Hz	T 400 mA (5x20 mm) Art.Nr. 00153002	1.05 kg
CXE/AVCE	320008			0.85 kg
CXE/AVC	320007	2~ 208 .. 415V (-15 % bis +10 %), 50/60 Hz	T 400 mA (6,3 x 32mm) Art.Nr. 00153840	1.05 kg

- Input resistance for sensor or signal set for the rotational speed:
- for 0-10 V input: $R_i > 100 \text{ k}\Omega$ / - bei Eingang 4-20 mA: $R_i = 100 \Omega$
- Voltage supply e.g. for sensors +24 V $\pm 20 \%$, I_{max} 120 mA (for connection to an external AXG terminal minus ca. 50 mA)
- Output (0-) 10 V, I_{max} 10 mA (short-circuit-proof)
- Heat dissipation approx. 6.5 W
- Max. line fuse 10 A
- The clock is buffered and has a 2-3 day reserve
- Max. permissible ambient temperature 40° C
- Min. permissible ambient temperature 0° C (if mains voltage is not switched off up to -20°C)
- Permissible rel. humidity 85 % no condensation
- Interference emission EN 61000-6-3
- Interference immunity EN 61000-6-2

3.3 Versions Unicon

Type CXE/AVC Housing version IP54 for wall mounting

Type CXE/AVCE for panel mounting (IP54 mounted)

4. Installation

4.1 Wall-mounting, installation in a switching cabinet

- For CXE/AVC Housing version for wall mounting
Assemble the device on a clean and stable base. Do not distort during assembly! Use the appropriate mounting devices for proper installation of the unit!
- For CXE/AVCE for panel mounting
The installation cutout of the controller amounts to 206 x 118 mm (⌀ dimensions). Bring the controller into the installation cutout and hang up you the enclosed clamps laterally. Subsequently, you screw the threaded rods with a screwdriver against the housing.
- Do not mount equipment on vibrating base!
- Install the device away from transport routes. However, ensure however that the device is still easily accessible!
- Cable ducts must remain freely accessible!
- Protect the device from direct exposure to sunlight!
- The device is designed for vertical installation A reclined installation is only permissible after consultation with the manufacturer.

4.2 Outdoor installation

Outdoor installation is possible up to -20°C when the controller supply is not switched off.

Installation must be protected from the effects of weather as much as possible, including protection from direct sunlight!

4.3 Installation location for agriculture

In order to avoid damage caused by ammoniac vapours (NH₃), the controller shall not be installed in the stable, but rather in an outhouse wherever possible.

4.4 Temperature influences during commissioning

Avoid condensation in the controller and hence functional faults attributable to condensation by storing the controller at room temperature!

4.5 Potential at control voltage connections

The control voltage connections (<50 V) relate to the joint GND potential (Exception: Relay contacts are potential free). There is a potential separation between the control voltage connections and the earthed conductor.

It must be ensured that the maximum external voltage at the control voltage connections cannot exceed 50V (between „GND“ terminals and „PE“ earthed conductor).

5. Electrical connections

5.1 Mains connection

Power from the mains is connected to terminals: PE, L1 and N. Here, it must be strictly observed that the mains voltage lies within the allowable tolerance specifications (☞ General description: Technical data and nameplate affixed to the side).

The supply voltage has to correspond to DIN EN 50160!

5.2 Signal cable (sensor cable)

Pay attention to sufficient distance from powerlines and motor wires to prevent interferences.

The control cables may not be longer than 30 m. Screened control cables must be used when the cable length is longer than 20 m. When using a screened cable, the screen must be connected to the protective conductor at one end, i.e. only at the control unit (as short and of as low an inductance as possible!).

5.3 Signal connection to analog inputs (Analog IN1, Analog IN2, ..)

The controller can work with 2 analog inputs, dependent on the type of signals must the appropriate terminals connected.

Signal type	Connection terminals
Input 1 for Temperature sensor TF..	7 – 8 (to pay attention to no polarity)
Input 2 for Temperature sensor TF..	9 - 10 (to pay attention to no polarity)
Input 1 for 4..20mA (0..20mA)	11 - *12 (with Two-wire-technology)
Input 2 for 4..20mA (0..20mA)	13 - *14 (with Two-wire-technology)
Input 1 for 0-10 V	15 (+) - 16 (GND)
Input 2 for 0-10 V	17 (+) - 18 (GND)

Ensure correct polarity when connecting; a 24 V DC power supply is integrated for sensors.

*For sensors in two-wire-technology (4-20 mA signal), the connection is made on the +24 V and terminals „11“ (Input 1) or “13“ (Input 2) the GND terminal is omitted.

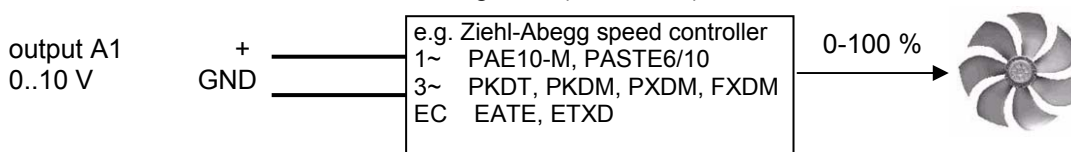
For three wire technology connection to GND terminal is necessary (terminals 8,10,16,18)

The connection is independent of the programmed operating mode and from the sensor signal employed (☞ Presets of the selected operating mode).

5.4 Output voltage 0-10 V (Analog OUT1 und Analog OUT2)

Analog output 1 (Analog OUT 1) is pre-programmed control outpute.g. for controlling a speed controller for fans.

Connection to terminal „A“ - „GND“ = Analog OUT (I_{max} 10 mA)



Analog output 2 (Analog OUT 2) is pre-programmed for constant voltage +10 V. E.g. supply for external potentiometer connection to terminals „A2“ - „GND“ = Analog OUT 2 (I_{max} 10 mA)

Both 0-10 V analog outputs can be allocated with various functions (☞ IO Setup: Analog output A1 or A2).

5.5 Voltage supply for external devices (+24 V, GND)

A voltage supply is integrated for external devices, e.g., for a sensor.

Terminal +24 V Output voltage tolerance $\pm 20\%$.

Max. load current 120 mA (for connection to an external AXG terminal minus ca. 50 mA)

During an overload or short-circuit (24 V \leftrightarrow GND), the control voltage (and thus the controller) is disconnected (Multifuse). Automatic start after elimination of the cause of error

5.6 Relay outputs (K1, K2)

Various functions can be allocated to the relay outputs K1 and K2

(☞ IO Setup: Function and inversion of the relay outputs). Max. contact load 5A / 250 V AC

Connection of the floating contacts of relay K1 to the terminals 1, 2, 3

Connection of the floating contacts of relay K2 to the terminals 4, 5, 6

5.7 Digital inputs (D1 .. D5)

Various functions can be allocated to the digital inputs D1 ..D5
 (☞ IO Setup: Functions summary of the digital inputs).
 Activation via floating contacts (a low voltage of ca. 24 V DC is connected).



Never apply external voltage to the digital inputs!

5.8 Connection RS-485 interface for MODBUS

The device comes equipped via a RS-485 interface for networking via a MODBUS. The data connection lead is connected to **D+**, **D-** and **GND**.
 The data connector spring-loaded contact is suitable for solid conductors of up to 0.5 mm² cross-section or 0.8 mm diameter. The stripped lead makes contact by itself upon insertion. The orange colored latch only needs to be pushed in the case of smaller cross-sections or when detaching the connections.

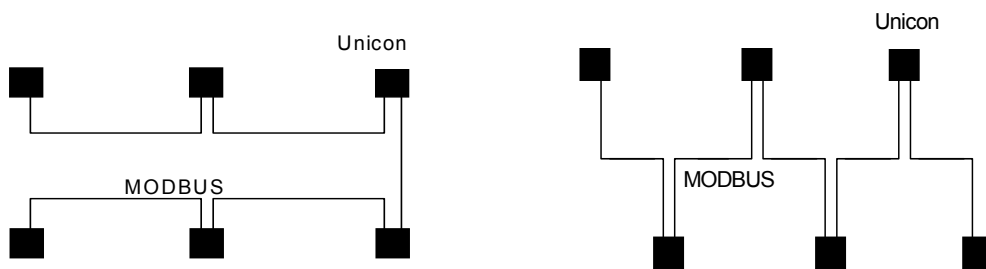


You must ensure correct connection; i.e. „**D+**“ must also be connected on the following devices to „**D+**“. The same applies to „**D-**“.
In addition, a GND connection must be established, as dissimilar potential (over 10 V!) will lead to the destruction of the RS-485 interface (e.g. lightning).



The data line must be conducted from one device into the next. To do this, two connectors are available in each device. No other type of wiring is allowed.
 Always use only two wires of one lead for the connection.
 When using telephone flex with four cable cores, we recommend the following allocation:
 „**D+**“ = red „**D-**“ = black „**GND**“ = white

Examples:



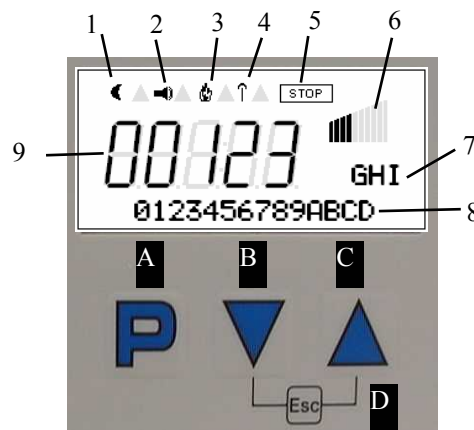
A maximum of 247 network users can be connected to the data bus .

6. Controls

6.1 Multipurpose LC display

- 1 Moon-Symbol for set point 2
- 2 Alarm-Symbol (fault indication)
- 3 Fire-Symbol (heating operation)
- 4 Antenna-Symbol (Remote-Control active)
- 5 STOP-Symbol (enable)
- 6 Bargraph (intern control output)
- 7 Text line 3 figures (display unit, etc.)
- 8 Text line 16 figures (display text menu.)
- 9 Numeric display 5 digit

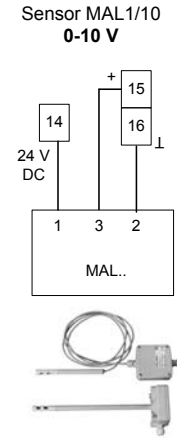
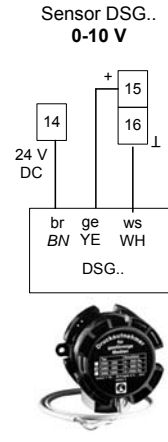
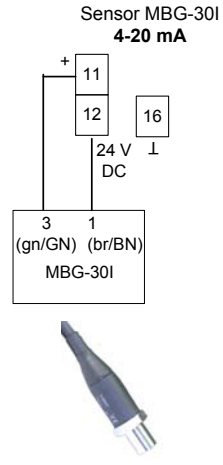
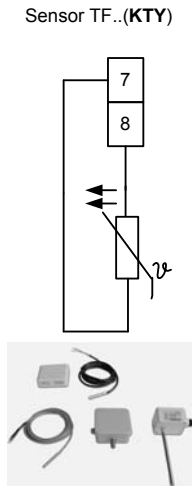
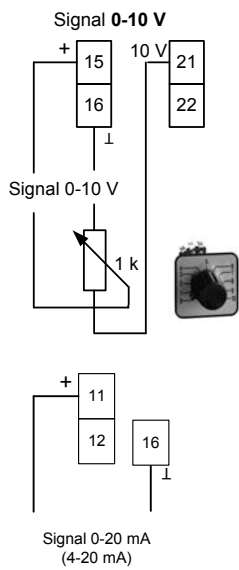
- A** P-key (program key, open menu)
- B** arrow -down-key (Menu down, reduce value)
- C** arrow-up-key (Menu up, increase value)
- D** ESC-key combination (↑ + ↓)
Escape, leave menu)



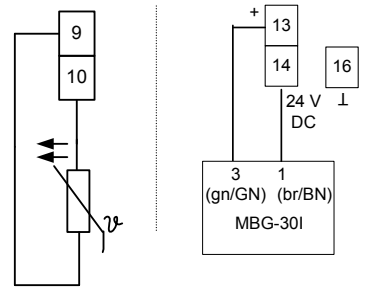
7. Connection terminals depending on input signal 

Dependet ont the type of signal must the appropriate terminals connected. If necessary configuration of sensors in menu „E1 Analog IN“ or. „E2 Analog IN“ .

Analog IN 1 „E1“

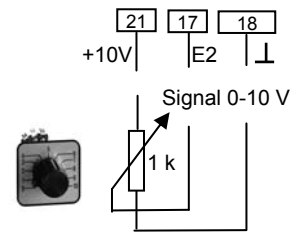


Analog IN 2 „E2“ for modes with two sensors



7.1 External Setpoint / External speed setting in manual operation

External Setpoint or external manual operation is possible by 0-10 V (0-20 mA, 4-20 mA) Signal at terminals „E2“ and „GND“. Place internal Jumper E2.1 and E2.2 for Analog IN 2 in correct position. Configuration in base setup. For Potentiometer Analog OUT 1 (terminal „A“) program to function 1A = +10 V (like factory setting IO Setup). If a second sensor is connected at input 2, external Setpoint or speed setting in manual operation is possible with additional modul “ZmodulB“ (input E3).



External Setpoint via external signal instead of „Setpoint 1“

The „External Setpoint“ function must be activated in base setup **1E** for **E2 function**; The active external Setpoint value is displayed in the info menu group.



External speed setting in manual operation

The „External manual operation“ function must be activated in the basic settings **2E** for **E2 function**. Switchover between settings on the device and external manual operation via the digital input or imer (IO Setup: Internal / External or timer).

8. Mode selection**8.1 Selection of the mode of operation**

Simple installation is possible through the selection of the preprogrammed mode of operation. This determines the basic function of the device; factory setting 1.01 = speed controller (activation via 0-10 V signal).

The controller configuration is automatically carried out during selection of the application related mode of operation. The factory presets in accordance with the mode of operation are based on many years of experience, which is suitable for many applications. Under special circumstances, these can be individually adapted (☞ Controller Setup: Controller Configuration).

The purpose of the device is to reach and maintain the target values set. To accomplish this, the measured actual value (sensor value) is compared with the adjusted target value, and the controlled value (modulation) is deduced from this.

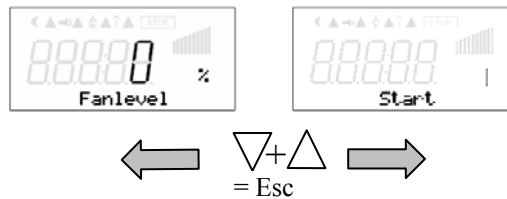
Mode	Signal or Sensor (input)	Function
1.01	Signal 0-10 V (E1)	Speed controller, two step operation (factory setting)
2.01	Sensor TF..(E1)	Temperature control airconditioning and refrigeration (preset set-point 20.0 °C, P-band 5K)
2.02	Sensor TF..(E1)	Temperature control depending on outdoor temperature (preset set-point 5.0 °C, - P-band 20 K)
2.03	Sensor TF..(E1)	Temperature control with additional functions (shutter and heating)
2.04	1x Sensor TF..(E1) 1x Sensor TF..(E2)	Temperature control with two sensors, comparison or average
2.05	1x Sensor TF..(E1) 1x Sensor TF..(E2)	Temperature control with two sensors differential temperature
3.01	Sensor MBG.. (E1)	Pressure control condensers (refrigeration)
3.02	Sensor MBG..(E1)	Pressure control for condensers with input for refrigerant
3.03	1x Sensor MBG..(E1) 1x Sensor MBG..(E2)	Pressure control for two circuit condensers
3.04	1x Sensor MBG..(E1) 1x Sensor MBG..(E2)	Pressure control for two circuit condensers with input for refrigerant
4.01	Sensor DSG..(E1)	Pressure control for ventilation systems
4.02	1x Sensor DSG..(E1) 1x Sensor TF..(E2)	Pressure control depending on outdoor temperature
5.01	Sensor DSG..(E1)	Volume control (constant) for ventilation systems
5.02	1x Sensor DSG..(E1) 1x Sensor TF..(E2)	Volume control with setpoint depending on outdoor temperature
6.01	Sensor MAL.. (E1)	Air velocity control

8.2 Menu operation

Display after turning on the mains voltage

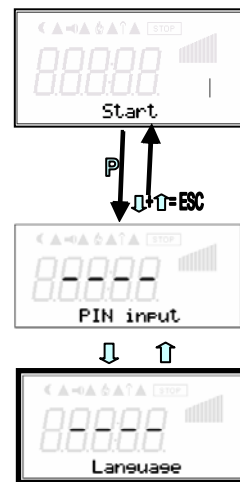


Switch-over between **Fanlevel** and **Start** or **actual value** with the key shortcut for Escape (Esc = ↑ + ↓).



Example for mode **1.01** language English

One reaches the menu item **START** by pushing the **P** key.
 One moves up and down within the menu group using the arrow keys.
 One returns to the menu group using the **ESC** (↑ + ↓) shortcut keys.



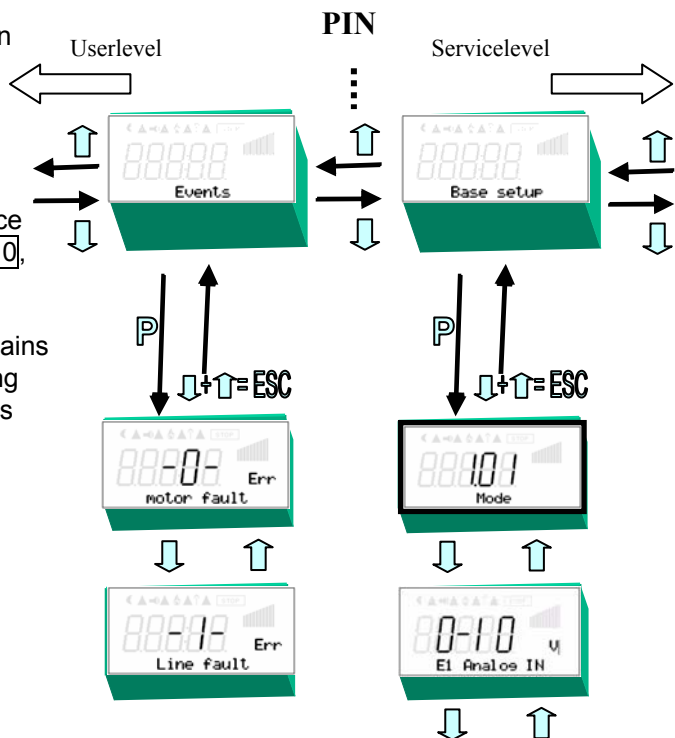
Selection of the menu group to the right through the down key, to the left through the up key.

The menu groups consist of one area for the user (user menu) and one area for installation (service).

The service area can be protected against unauthorized access by using a PIN.

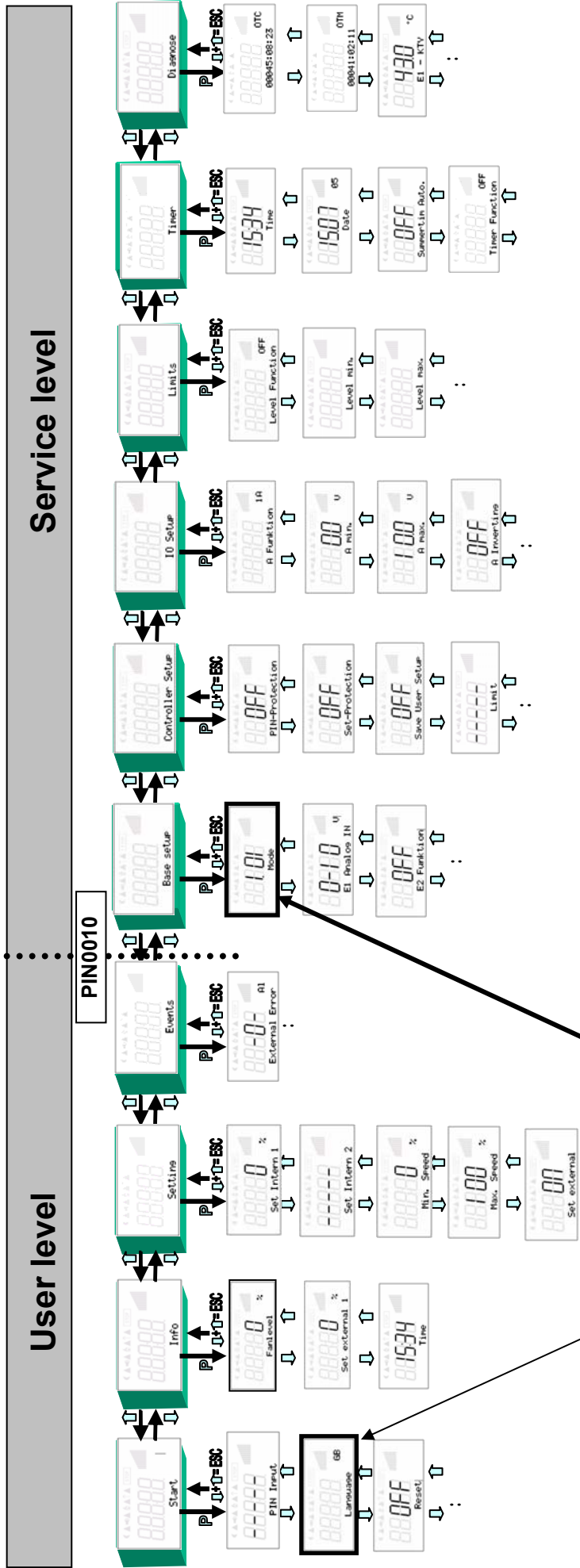
In order to simplify the initial start-up operation, the service level is enabled at first (i.e., not protected by the **PIN 0010**, see Controller Setup, PIN protection = OFF).

If PIN protection is activated (ON), the service menu remains enabled after input of **PIN 0010** as long as one is pressing keys. If no keys are pressed for ca. 15 minutes, the PIN is automatically erased, i.e. the service level is blocked.



After installation of the device has been carried out, PIN protection should be activated!





If necessary select menu language
 (factory default - English)

Selection mode of operation
 (factory setting **1.01** = speed controller)

i Caution! When saving the operating mode, the respective preset factory operating-mode setting is loaded. That means, the settings you have made, e.g., in „Motor setup“ are lost. An exception: the menu language setting remains preserved.

9. Programming

9.1 Speed controller 1.01

9.1.1 Basic setting 1.01

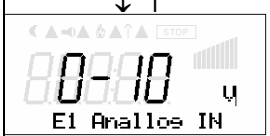


↓P ↑ESC



Factory setting Mode **1.01**

↓ ↑



Factory setting 0-10 V
Selection : 0-20 mA, 4-20 mA, Bus
Inverting in IO Setup

↓ ↑



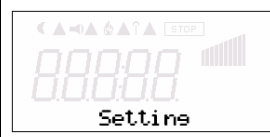
Analog input 2 „E2“ factory set at **OFF**

- For operation with a second signal and switch over via floating contact (☞ IO Setup) set to function **1E**.
- For operation with a second signal and automatic control at the higher level. Set E2 Funktion to **4E**.

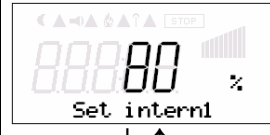
↓ ↑



9.1.2 Setting for operation 1.01

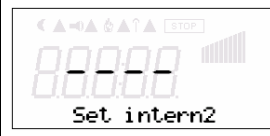


↓P ↑ESC



Manual speed setting
Set Internal 1

↓ ↑



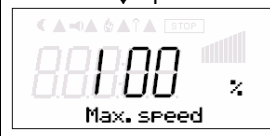
Set internal 2
Switch over 1/2 by external contact

↓ ↑



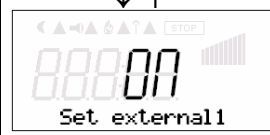
Minimal speed
0 - 100 %

↓ ↑



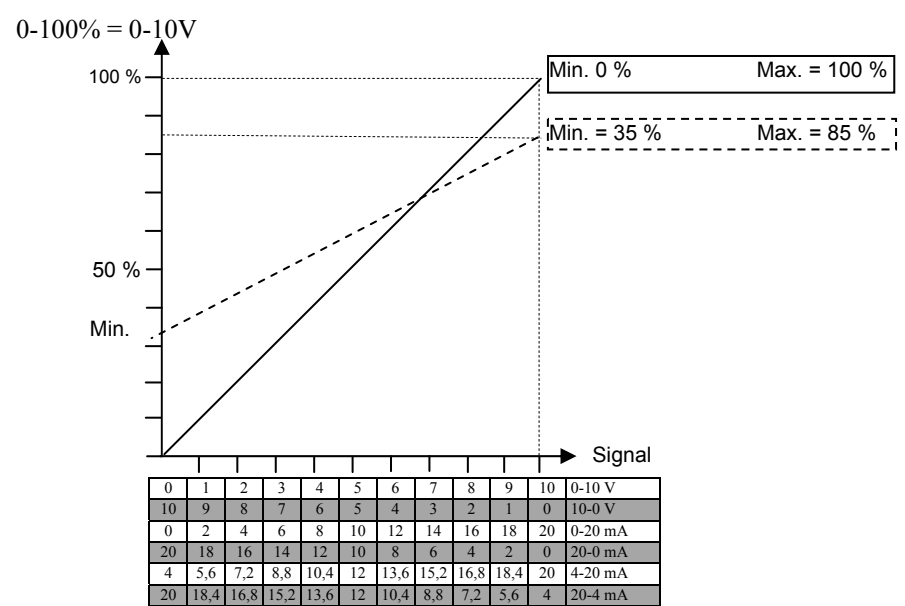
Maximal speed
100% - Min.

↓ ↑



ON = (factory setting)
speed setting by external signal
OFF =
Set internal 1

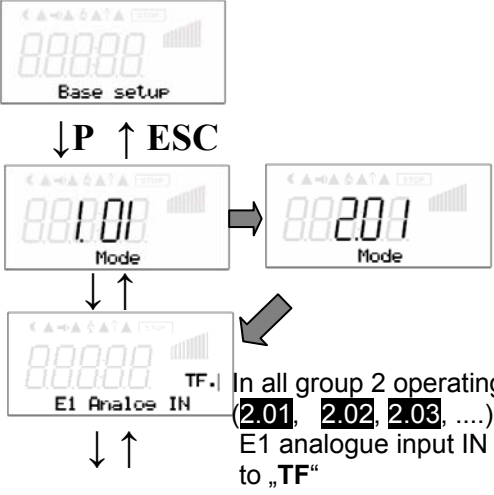







Diagram default signal and output voltage
Idealized principle diagram



9.1.3 Menu speed controller **1.01**

	Parameter	Factory setting	User Setting		
Start	PIN Input	.----			
	Language	GB			
	Reset	OFF			
	Mode	1.01			Only Display
	Unicon	1.06			
Info	Fanlevel	0%			
	Set external1	0%			
	Time	12:06			
	Date	18.07.05			
Setting	Set Intern 1	80%			
	Set Intern 2	.----			
	Min. Speed	0%			
	Max. Speed	100%			
	Set external 1	ON			
	External Error	*			
Events		*			
		*			
		*			
INSTALLATION					
Base setup	Mode	1.01			
	E1 Analog IN	0-10V			E2 Function
	E2 Function	OFF		1E	E1/E2 switch over
	E2 Analog IN	.----		4E	E1/E2 autom. control to higher value
Controller Setup	PIN Protection	OFF			
	Set protection	OFF			
	Save User Setup	OFF			
	Limit	.----			
	ON Value Group 2	.----			
	nminm at Group 2	.----			
IO Setup	A1 Function	2A			A1 / A2 Function
	A1 min.	0.0 V		1A	Constant voltage + 10V
	A1 max.	10.0 V		2A	proportional modulation
	A1 Inverting	OFF		3A	proportional signal E1
	A2 Function	1A		4A	proportional signal E2
	A2 min.	0.0 V		5A	Group control
	A2 max.	10.0 V			
	A2 Inverting	OFF			
	D1 Function	OFF			D1..D5 Funktion
	D1 Inverting	.----		1D	Enable ON / OFF
	D2 Function	OFF		2D	External fault
	D2 Inverting	.----		3D	Limit ON / OFF
	D3 Function	OFF		4D	Switch over Singnal E1/E2
	D3 Inverting	.----		5D	switch over Intern 1 / 2
	D4Function	OFF		6D	switch over:Set Intern / Extern
	D4 Inverting	.----			
	D5 Function	OFF			
	D5 Inverting	.----			K1 / K2 Function
	E1 Inverting	OFF		1K	Operation indication
	E2 Inverting	.----		2K	Fault indication
	K1 Function	1K		3K	external fault
	K1 Inverting	OFF		4K	Limit modulation
	K2 Function	2K		5K	Limit E1
	K2 Inverting	OFF		6K	Limit E2
BUS Address	247		8K	Group control	
Limits	Level. Function	OFF			Limits (Lmt. Function)
	Level min.	.----		1L	Indication with centralized fault
	Level max.	.----		2L	Indication as message
	Level Delay	.----			
	Lmt E1 Function	OFF			
	Lmt E1 min.	.----			
	Lmt E1 max.	.----			
	Lmt E1 Hyst.	.----			
	Lmt E1 Delay	.----			
	Lmt E2 Function	.----			
	Lmt E2 min.	.----			
	Lmt E2 max.	.----			
Lmt E2 Hyst.	.----				
Lmt E2 Delay	.----				
Timer	Time	13:25			
	Date	18.07.05			
	Summertime Auto.	OFF			
	Timer Function	OFF			
	Mon				
	Mon ON1	--:			
	Mon OFF1	--:			
	Mon ON2	--:			
Mon OFF2	--:				

Diagnostics Menu see chapter 16

<p>9.2 Temperature control 2.01..2.05</p>	
<p>9.2.1 Basic setting 2.01..2.05</p>  <p>In all group 2 operating modes (2.01, 2.02, 2.03,) E1 analogue input IN factory set to „TF“</p>	<p>Function analog Input 2</p>  <ul style="list-style-type: none"> • External setpoint = Function 1E by external signal (0-10 V) instead of „Set point 1“ For sensor type „E1 TF“.: 0-10 V $\hat{=}$ -27°C..+75.0°C For sensors with active signal: 0-10 V $\hat{=}$ 0-100 % sensor measuring range • External manual operation via external signal (0-10V) = function 2E Switch over between settings on the device and external manual operation via digital input (☞ IO Setup). • Measurement value = function 7E e.g. for limit indication, display in Info menu “E2 actual” • Modes with two sensors The function is automatically jointly programmed in operating modes using 2 sensors. The second analog input is thus allocated and additional function allocations are not possible. <p>2.04 E2 Function at 4E preprogrammed = comparison value with control to higher temperature. alternative: average of 2 measuring points for this must be reprogrammed on function 3E preprogrammed sensor type TF..</p> <p>2.05 E2 Function at 5E preprogrammed = regulation on difference temperature between sensor 1 and sensor 2. Preprogrammed sensor type TF..</p>
<p>Alternative selection signal: 0-10 V, 0-20 mA, 4-20 mA, jumper accordingly inserted. The sensor measurement-range must be entered in order to correctly display the actual value. Example with a 0-10 V sensor and 0-100° C measurement range</p>	
    	<p>Initial value measuring range</p> <p>Final value measuring range</p> <p>Decimal places</p> <p>display unit</p>
	<p>Sensor calibration with calibrated comparison device</p>

9.2.2 Settings for operation modes 2.01 .. 2.05

2.01

Temperature control

2.02

Temperature control depending on outdoor temperature

2.03

Temperature control with additional functions (heating, shutter, temp. monitoring)

2.04

Temperature control with two sensors.

- comparison with control to higher value „E2 Function“ set to comparison „4E“. display during operation: "Control value".
- Alternative: Average calculation of 2 measuring places Display during operation: "Average E1 / E2 („E2 Function“ set to „3E“)

2.05

Temperature control with 2 sensors, regulation on difference temperature

display during operation: "Value of E1 - E2 in K, E1 = reference temperatur, E2 causes positiv (E2<E1) or negative (E2>E1) difference



↓ P ↑ ESC



Setpoint 1
Setting range: -27.0 .. 75°C

↓ ↑



Setpoint 2
„Setpoint 2“ (factory setting OFF)
e.g. reduced value for night operation. Switch over by digital input.
(As long as no allocation has been carried out: Display: - - - - ⚙ IO Setup).

↓ ↑



Pband (Control range)
The control response can be adjusted to the system conditions
- small control range = greater amplification and shorter control times
- big control range = longer control times and higher controller stability
Setting range: 0-102,0 K

↓ ↑



Min. Speed „n-min“ (minimum output voltage)
If required setting of a minimum output voltage e. g. basic speed (minimum airflow rate) of fans.
Setting range: 0 % up to 100 % (or Max. speed).

↓ ↑



Max. Speed „n-max“ (maximum output voltage)
If required setting of a maximum output voltage, e. g. speed limiter.
Setting range: 100 % down to „Min speed“.

↓ ↑



Manual mode
OFF = automatic control as function of the set parameters
ON = automatic control without function, speed setting in menu "Speed manual"

↓ ↑



Speed manual
Manual speed setting without influence by the external signal
Activation by menu „Manual mode“ or external contact at digital input (⚙ IO Setup).

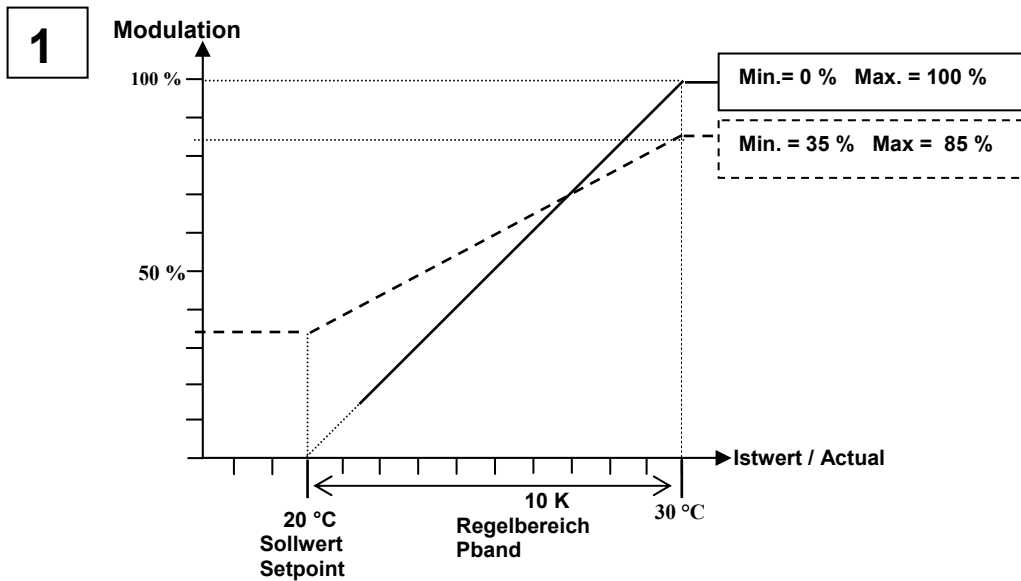
For information about deactivated regulation the adjusted value for manual speed is indicated alternating with the actual value

9.2.3 Functional diagrams temperature control

Example 1:

Temperature control in **factory setting** „Cooling function“ (Controller Setup: $Ist > Soll = n+$ ON)

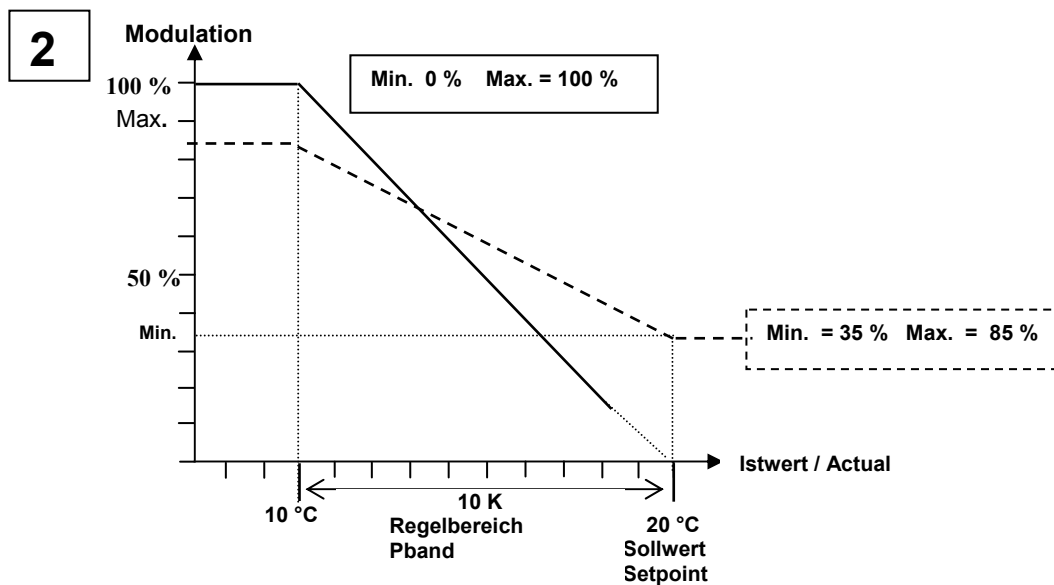
(Idealized principle diagram)



Example 2:

Temperature control in „Heating function“ (Controller Setup: $Ist > Soll = n+$ OFF)

(Idealized principle diagram)



9.2.4 For mode **2.03** temperature controller with additional functions: Signal output 0-10 V

The 0-10 V output signal can, e.g., be used for triggering a shutter or heating.

The target value for this output is the target value (Setpoint) for the ventilation \pm offset setting. Adjustment range ± 10 K relative to the active Setpoint.

Example for triggering a shutter servomotor:

At factory setting „0 K“ = synchronous operation.

The analog output is factory set to increasing activation during increasing temperature.

Reprogramming to „Heating function“, i.e., increasing modulation during decreasing temperature is possible (☞ IO Setup).



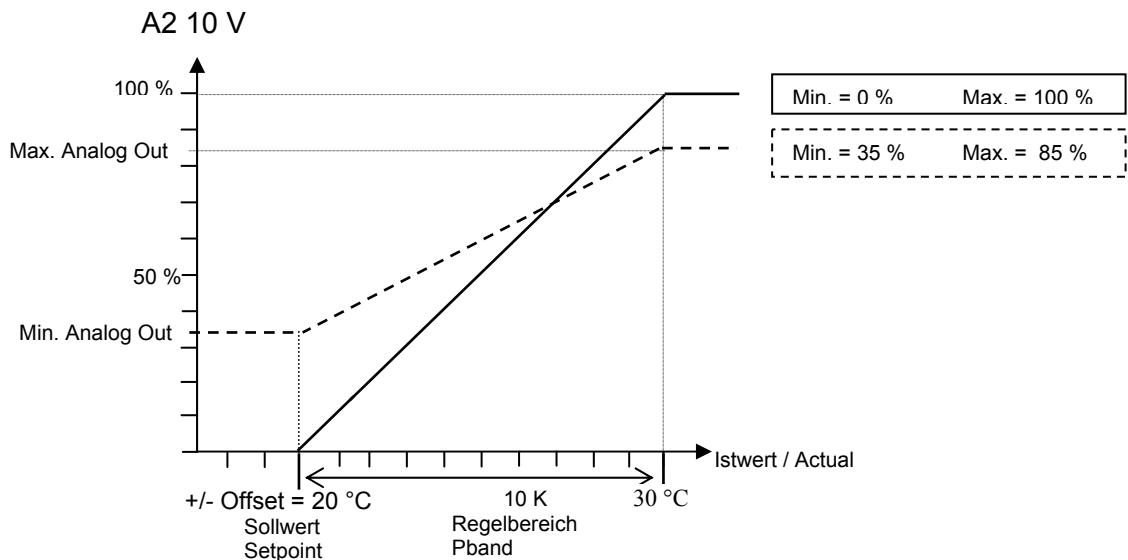
Pband = separately adjustable range of control (P-band) for 0-10 V output

Min Analog Out = Minimal output voltage, setting range 0-100 % = 0-10 V

Max. Analog Out = Maximal output voltage, setting range 100-0 % = 10-0 V

Example for signal out 0-10 V

- Setpoint ventilation 25°C
- Offset -5 K
- Pband 10 K



9.2.5 For mode **2.03** Relay output for Heating or Cooling



Offset Digital Out = Offset for relay output (K2 is pre-programmed by the factory)

The relay operating point deviates by the adjusted offset of the Setpoint of the ventilation (if relay K2 not inverted, terminal „21“-„24“ bridged).

0.0 K set, i.e.

During negative offset value

During positive offset value

heating „ON“ when: actual value = Setpoint

heating „ON“ when: actual value = Setpoint - offset

heating „ON“ when: actual value = Setpoint + offset



The switching hysteresis of the relay is set to 1 K at factory **Hyst. Digital Out**.

Example 1

Temperature variation with factory setting **9 K in IO Setup e. g. for controlling a **Heating****

If the ambient temperature is lower than the set operating point, the heating remains switched on. If the ambient temperature exceeds the set operating point of the heating by 2 K, the heating is switched off. I.e., the release point is situated at the hysteresis value over the operating point.

The activated heating is indicated over the fire symbol in the display



Example 2

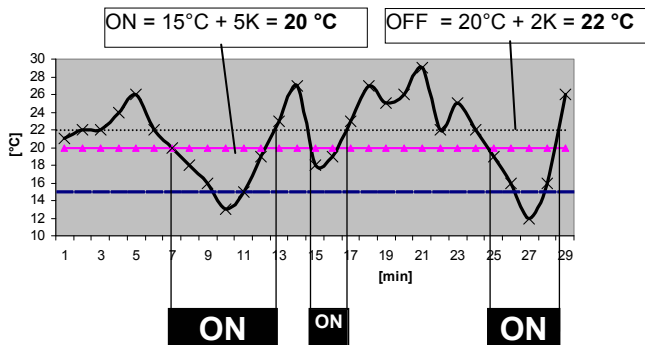
Temperature variation with reprogramming to **10K in IO Setup, e.g., for activation of the **cooling****

If the ambient temperature is higher than the set operating point, the cooling remains switched on.

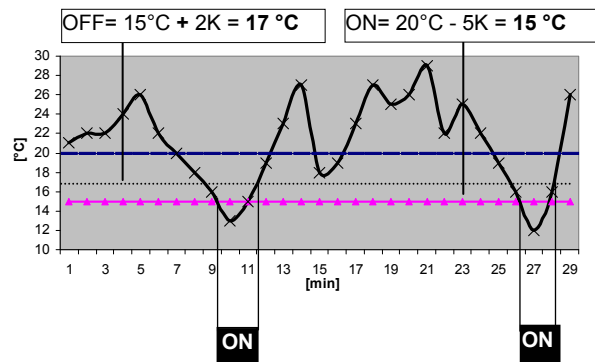
If the ambient temperature falls below the set operating point of the cooling by 2 K, it is switched off. I.e., the OFF point is situated at the hysteresis value under the ON point.

IO Setup K2 Function for **Heating = **9K****

Example 1: Setpoint 15°C, Offset +5K, Hysteresis 2 K

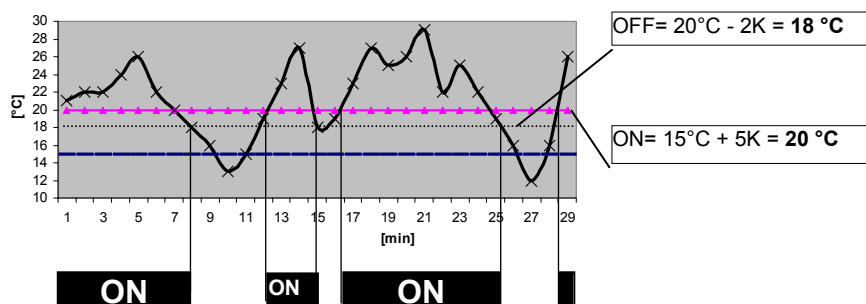


Example 1: Setpoint 20°C, Offset -5K, Hysteresis 2 K



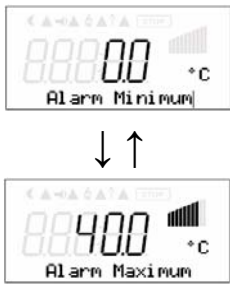
IO Setup K2 Function for **Cooling = **10K****

Example 2: Setpoint 15°C, Offset +5K, Hysteresis 2 K

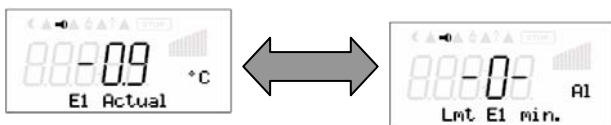


9.2.6 For mode **2.03** Relay output for temperature monitoring

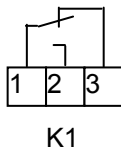
If the set value for the minimum alarm is not reached or the set value for the maximum alarm is exceeded, a message is generated via the alarm symbol in the display. In addition, „Lmt E1 min“ is displayed alternately with the actual value for the minimum alarm and Lmt E1 max for the „Maximum alarm“. An external message follows via the factory-assigned K1 relay. (IO Setup : K1 function = **2K**)



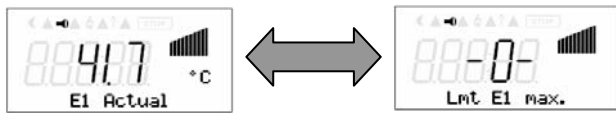
Example for display if temperature is falling below setting „Alarm Minimum“



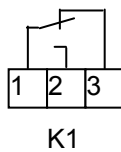
Relay K1 disengages (if not inverted)



Example for display if temperature is exceeding setting „Alarm Maximum“



Relay K1 disengages (if not inverted)



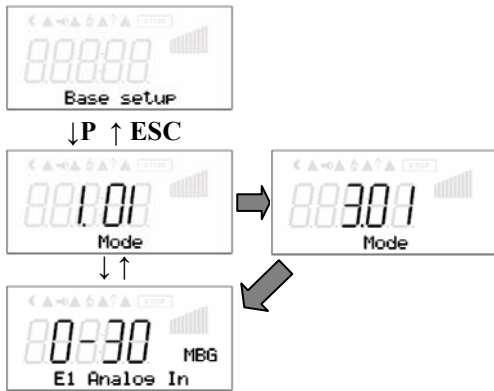
	Parameter	factory setting					User Setting	
S t a r t	PIN Input	---	---	---	---	---		
	Language	GB	GB	GB	GB	GB		
	Reset	OFF	OFF	OFF	OFF	OFF		
	Mode	2.01	2.02	2.03	2.04	2.05		
	Unicon	1.06	1.06	1.06	1.06	1.06		
							Only Display	
I n f o	Value E1-E2						-2.4°C	
	Control value				26.1°C			
	E1 Actual	30°C	10°C	30.0°C	22.9°C	21.9°C		
	E2 Actual	---	---	---	26.1°C	24.3°C		
	Setpoint 1	20.0°C	5.0°C	20.0°C	20.0°C	0.0°C		
	Fanlevel	0,5	0,25	0,5	1	0		
	Misco.	OFF	OFF	OFF	OFF	OFF		
	Time	12:06	12:06	12:06	12:06	12:06		
	Date	18.07 05	18.07 05	18.07 05	18.07 05	18.07 05		
S e t t i n g	Setpoint 1	20.0°C	5.0°C	20.0°C	20.0°C	0.0°C		
	Setpoint 2	---	---	---	---	---		
	Pband	5.0 K	20.0 K	5.0 K	5.0 K	5.0 K		
	Min. Speed	0%	0%	0%	0%	0%		
	Max. Speed	100%	100%	100%	100%	100%		
	Manual mode	OFF	OFF	OFF	OFF	OFF		
	Speed manual	100%	100%	100%	100%	100%		
	Offset AnalogOut			0.0K				
	Pband AnalogOut			2.0K				
	Min. AnalogOut			0%				
	Max. AnalogOut			100%				
	OffsetDigitalOut			-1.0K				
	Hyst.DigitalOut			1.0K				
	Alarm Minimum			0.0°C				
Alarm Maximum			40.0°C					
E v e n t s	External Error	*	*	*	*	*		
	Sensor 1	*	*	*	*	*		
INSTALLATION								
B a s e s e t u p	Mode	2.01	2.02	2.03	2.04	2.05		
	E1 Analog IN	TF	TF	TF	TF	TF		
	E1 Min.	---	---	---	---	---	2.01 Temperature control	
	E1 Max.	---	---	---	---	---		
	E1 Decimals	---	---	---	---	---	2.02 Temperature control depending on outdoor temperature	
	E1 unit	---	---	---	---	---		
	E1 Offset	0.0K	0.0K	0.0K	0.0K	0.0K	2.03 Temperature control with additional functions: Heating, shutter, temp. Monitoring	
	E2 Function	OFF	OFF	OFF	4E	5E		
	E2 Analog IN	---	---	---	TF	TF		
	E2 Min.	---	---	---	---	---	2.04 Temperature control with two Sensors comparison with control to higher value average calculation of 2 measuring places	
	E2 Max.	---	---	---	---	---		
	E2 Decimals	---	---	---	---	---		
	E2 unit	---	---	---	---	---		
	E2 Offset	---	---	---	0.0K	0.0K	2.05 Temperature control of 2 sensors regulation on difference temperature	
C o n t r o l l e r S e t u p	PIN Protection	OFF	OFF	OFF	OFF	OFF		
	Set protection	OFF	OFF	OFF	OFF	OFF		
	Save User Setup	OFF	OFF	OFF	OFF	OFF		
	Alarm Sensors	OFF	OFF	OFF	OFF	OFF	E2 Funktion	
	Limit	---	---	OFF	---	---	1E 0-10 V external Setpoint	
	Misco.	OFF	OFF	OFF	OFF	OFF	2E external manual mode	
	ON Value Group2	---	---	---	---	---	3E Sensor average to E1	
	nminm bei Gruppe2	---	---	---	---	---	4E Sensor comparison to E1	
	Val>Set = n+	ON	ON	ON	ON	ON	5E Sensor difference to E1	
	Type of control	P	P	P	P	P	6E Sensor for setpoint lowering (only for mode 4.02 and 5.02)	
	KP	50%	50%	50%	50%	50%	7 E measurement value for indication and display	
	KI	50%	50%	50%	50%	50%		
KD	50%	50%	50%	50%	50%			
TI	0%	0%	0%	0%	0%			

	2.01	2.02	2.03	2.04	2.05	User Setting						
IO Setup	A1 Function	2A	2A	2A	2A	2A		A1 / A2 Funktion				
	A1 min.	0.0 V	0.0 V	0.0 V	0.0 V	0.0 V	1 A	Constant voltage + 10V				
	A1 max.	10.0 V	10.0 V	10.0 V	10.0 V	10.0 V	2 A	proportional modulation				
	A1 Inverting	OFF	OFF	OFF	OFF	OFF	3 A	proportional signal E1				
	A2 Function	1A	1A	6A	1A	1A	4 A	proportional signal E2				
	A2 min.	0.0 V	0.0 V	0.0 V	0.0 V	0.0 V	5 A	Group control				
	A2 max.	10.0 V	10.0 V	10.0 V	10.0 V	10.0 V	6 A	only 2.03 cooling				
	A2 Inverting	OFF	OFF	OFF	OFF	OFF	7 A	only 2.03 Heating				
	D1 Function	OFF	OFF	OFF	OFF	OFF		D1..D5 Funktion				
	D1 Inverting	.----	.----	.----	.----	.----						
	D2 Function	OFF	OFF	OFF	OFF	OFF	1 D				Enable ON / OFF	
	D2 Inverting	.---	.---	.---	.---	.---	2 D				External fault	
	D3 Function	OFF	OFF	OFF	OFF	OFF	3 D				Limit ON / OFF	
	D3 Inverting	.---	.---	.---	.---	.---	4 D				Switch over Singnal E1/E2	
	D4Function	OFF	OFF	OFF	OFF	OFF	5 D				switch over Setpoint 1 / 2	
	D4 Inverting	.---	.---	.---	.---	.---	6 D				switch over: Set Intern / Extern	
	D5 Function	OFF	OFF	OFF	OFF	OFF	7 D	Controlling / Manual intern				
	D5 Inverting	.---	.---	.---	.---	.---	8 D	switch over: ActualValue>Set=n+/-n-				
	E1 Inverting	OFF	OFF	OFF	OFF	OFF		K1..K4 Funktion				
	E2 Inverting	.---	.---	.---	.---	.---						
	K1 Function	1K	1K	1K	1K	1K	1 K				Operation indication	
	K1 Inverting	OFF	OFF	OFF	OFF	OFF	2 K				Fault indication	
	K2 Function	2K	2K	9K	2K	2K	3 K	external fault				
	K2 Inverting	OFF	OFF	OFF	OFF	OFF	4 K	Limit modulation				
BUS Address	247	247	247	247	247	5 K	Limit E1					
Level. Function	OFF	OFF	OFF	OFF	OFF	6 K	Limit E2					
Level min.	.---	.---	.---	.---	.---	7 K	Setpoint Offset					
Level max.	.---	.---	.---	.---	.---	8 K	Group control					
Level Delay	.---	.---	.---	.---	.---	9 K	only 2.03 heating funktion					
Lmt E1 Function	OFF	OFF	1L	OFF	OFF	10 K	only 2.03 cooling funktion					
Lmt E1 min.	.---	.---	0.0°C	.---	.---		Limits (Lmt. Function)					
Lmt E1 max.	.---	.---	40.0°C	.---	.---							
Lmt E1 Hyst.	.---	.---	1.0K	.---	.---							
Lmt E1 Delay	.---	.---	2sec	.---	.---							
Lmt E2 Function	.---	.---	.---	.---	.---	1 L				Indication with centralized fault		
Lmt E2 min.	.---	.---	.---	.---	.---	2 L				Indication as message		
Lmt E2 max.	.---	.---	.---	.---	.---							
Lmt E2 Hyst.	.---	.---	.---	.---	.---							
Lmt E2 Delay	.---	.---	.---	.---	.---							
Offset Function	OFF	OFF	OFF	OFF	OFF							
Offset 1	.---	.---	.---	.---	.---							
Offset 2	.---	.---	.---	.---	.---							
Offset Hyst.	.---	.---	.---	.---	.---							
Offset Delay	.---	.---	.---	.---	.---							
Timer	Time	13:25	13:25	13:25	13:25	13:25						
	Date	18.07 05	18.07 05	18.07 05	18.07 05	18.07 05						
	Summertime Auto.	OFF	OFF	OFF	OFF	OFF						
	Timer Function	OFF	OFF	OFF	OFF	OFF						
	Mon											
	Mon ON1	-:-	-:-	-:-	-:-	-:-						
	Mon OFF1	-:-	-:-	-:-	-:-	-:-						
	Mon ON2	-:-	-:-	-:-	-:-	-:-						
Mon OFF2	-:-	-:-	-:-	-:-	-:-							

Diagnostics | Menu see chapter 16

9.3 Pressure control for condensers refrigeration 3.01 .. 3.04

9.3.1 Basic setting 3.01 3.04



For all Modes in Group 3 (3.01, 3.02, 3.03)
 Analog input E1 factory setting to "MBG-30I"
 (measuring range 0-30 bar, proportional output 4-20 mA).
 Selection sensor: MBG-30I DSF2-25

Alternative selection signal: 0-10 V, 0-20 mA, 4-20 mA,
 jumper accordingly inserted. The sensor measurement
 range must be entered in order to display the actual value
 correctly.

Example: 0-10 V sensor and range 20 bar



Initial value measuring range



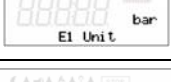
Final value measuring range



Decimal places



display unit



Sensor calibration with calibrated
 comparison device

3.02 and **3.04** operating modes with refrigerant for use with
 Ziehl-Abegg pressure sensor type MBG-30I or DSF2-25



Upon input of the refrigerant, the device automatically
 calculates the corresponding temperature for the
 measured pressure. The settings for offset, target value
 and the controlling range are then carried out in °C or K.
 Calculation for relative pressure (differential measurement
 of pressure relative to ambient pressure
 No further settings are necessary for pressure sensors
 from Ziehl-Abegg model e.g. MBG-30I (measurement
 range 0-30 bar). In the case of sensors with other
 measurement ranges, the „E1 Min value“ and the „E1 Max
 Value“ must be entered in °C. To do this, convert the bar
 values for min and max into °C.

Selection refrigerant :

R12	R13	R13b1	R22	R23	R32	R114	R134a	R142B
R227	R401	R401A	R401B	R402	R402A	R402B	R404A	R407A
R407B	R407C	R500	R502	R503	R507	R717		

Function Analog Input 2



- External setpoint = Function **1E**
 by external signal (0-10 V) instead of „Setpoint 1“
 0-10 V $\hat{=}$ sensor measuring range
- External manual = function **2E**
 operation via external signal (0-10V)
 Switch over between settings on the device and external
 manual operation via digital input
 (☞ IO Setup).
- Measurement value = function **7E**
 e.g. for limit indication, display in Info menu “E2 actual”
- Modes with two sensors
 The function is automatically jointly programmed in
 operating modes using 2 sensors. The second analog
 input is thus allocated and additional function allocations
 are not possible.

3.04 + 3.03

E2 Function at **4E** preprogrammed = comparison value with
 control to higher value (two circuit condensers).

9.3.2 Setting for operation 3.01 .. 3.04

3.01 Pressure control condensers, Setpoint in bar

3.02 Pressure control for condensers with input for refrigerant, Setpoint in °C

3.03 t w o sensors for dual circuit condenser, automatic regulation to the highest pressure (selection amplifier integrated) operation display: „Control value“, Setpoint in bar

3.04 t w o sensors for dual circuit condenser with input for refrigerant automatic regulation to the highest pressure (selection amplifier). Setpoint in °C , also for different refrigerants suitably there comparison of the temperatures. Display during operation: „Control value“



3.01 and 3.03 setting in bar

3.02 and 3.04 input for refrigerant setting in °C

Setpoint 1 (factory setting 12.0 bar)
Setting range:
in measuring range of sensor

Setpoint 1 (factory setting 35.0 °C)
Setting range:
in measuring range of sensor

Setpoint 2
Switch over 1/2 by external contact
(IO Setup)

Setpoint 2
Switch over 1/2 by external contact
(IO Setup)

Control range „Pband“
small range = great amplification and short control time
Big range = longer control times (higher controller stability)

Control range „Pband“
small range = great amplification and short control time
Big range = longer control times (higher controller stability)

Minimal speed
0-100 %

Minimal speed
0-100 %

Maximal speed
100% - Min.

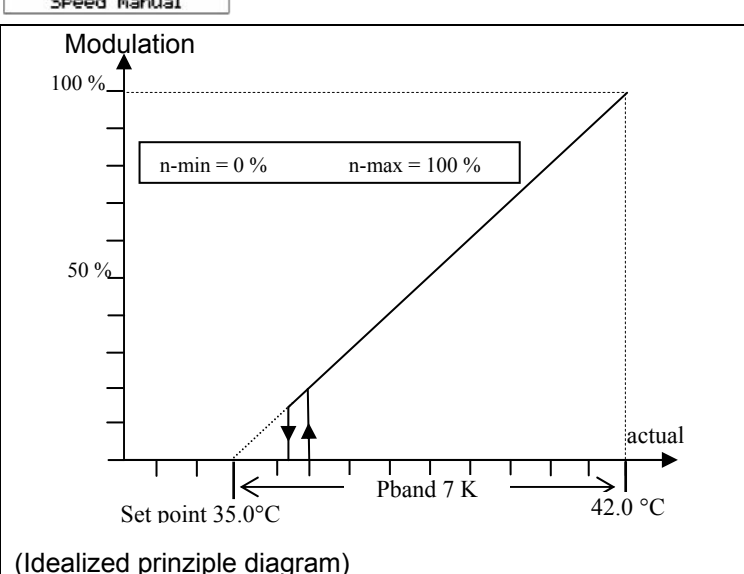
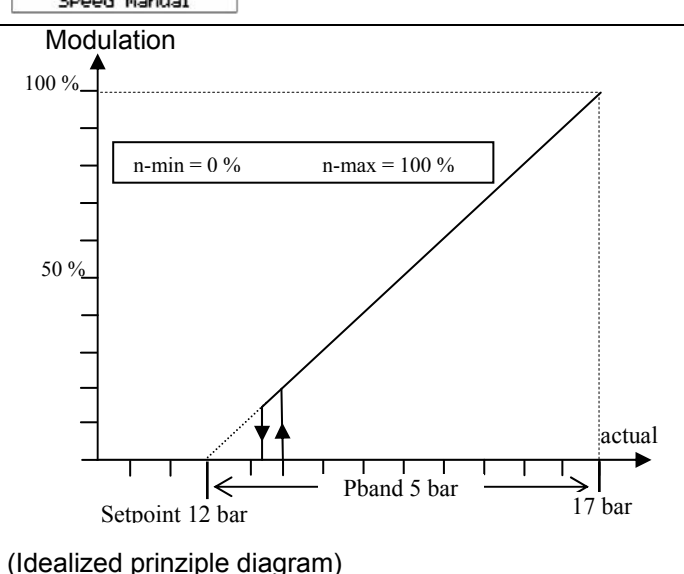
Maximal speed
100% - Min.

OFF = automatic control
ON = manual speed setting 0 - 100 %

OFF = automatic control
ON = manual speed setting 0 - 100 %

Manual speed setting
0 - 100 % if manual mode = ON

Manual speed setting
0 - 100 % if manual mode = ON



i The factory default presets must be adapted to match the system conditions by a competent person.

9.3.3 Menu for pressure control refrigeration **3.01** .. **3.04**

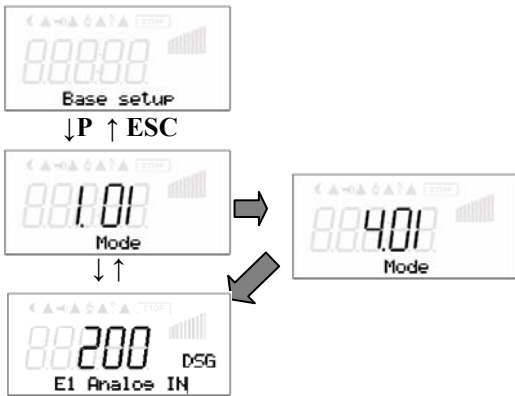
	Parameter	factory setting				User Setting	
Start	PIN Input	.---	.---	.---	.---		
	Language	GB	GB	GB	GB		only display
	Reset	OFF	OFF	OFF	OFF		
	Mode	3.01	3.02	3.03	3.04		
	Unicon	1.06	1.06	1.06	1.06		
Info	Control value			10.91 bar	22.6°C		
	E1 Actual	10.00 bar	19.5°C	9.95 bar	19.4 °C		
	E2 Actual	.---	.---	10.91bar	22.5°C		
	Setpoint 1	12.00 bar	35.0°C	12.00 bar	35.0°C		
	Fanlevel	0	0	0	0		
	Msc0.	OFF	OFF	OFF	OFF		
	Time	12:06	12:06	12:06	12:06		
	Date	18.07 05	18.07 05	18.07 05	18.07 05		
Setting	Setpoint 1	12.00 bar	35.0°C	12.00 bar	35.0°C		
	Setpoint 2	.---	.---	.---	.---		
	Pband	5.0 bar	7.0 K	5.00 bar	7.0 K	3.01	Pressure control condensers Setpoint in bar
	Min. Speed	0%	0%	0%	0%		
	Max. Speed	100%	100%	100%	100%	3.02	Pressure control condensers with input for refrigerant Setpoint in °C
	Manual mode	OFF	OFF	OFF	OFF		
	Speed manual	100%	100%	100%	100%		
Events	External Error	*	*	*	*		
	Sensor 1	*	*	*	*	3.03	2 sensors for dual circuit condensers regulation to the highest actual value (selection amplifier integrated) Setpoint in bar
INSTALLATION							
Base setup	Mode	3.01	3.02	3.03	3.04	User Setting	3.04 2 sensors for dual circuit condensers with input for refrigerant regulation to the highest actual value (selection amplifier integrated) Setpoint in °C also for different refrigerants suitably there comparison of the temperatures
	E1 Analog IN	0-30 MBG	0-30 MBG	0-30 MBG	0-30 MBG		
	E1 Refrigerant		R507		R507		
	E1 Min.	.---	.---	.---	.---		
	E1 Max.	.---	.---	.---	.---		
	E1 Decimals	.---	.---	.---	.---		
	E1 Unit	.---	.---	.---	.---		
	E1 Offset	0.00 bar	0.0K	0.00 bar	0.0K		
	E2 Function	OFF	OFF	4 E	4E		E2 Function
	E2 Analog IN	.---	.---	0-30 MBG	0-30 MBG		
	E2 Refrigerant				R507		1E 0-10 V external Setpoint
	E2 Min.	.---	.---	.---	.---		2E external manual mode
	E2 Max.	.---	.---	.---	.---		3E Sensor average to E1
	E2 Decimals	.---	.---	.---	.---		4E Sensor comparison to E1
	E2 Unit	.---	.---	.---	0.0K		5E Sensor difference to E1
E2 Offset	.---	.---	0.00 bar	0.0K		6E Sensor for setpoint lowering	
Controller Setup	PIN Protection	OFF	OFF	OFF	OFF		only for mode 4.02 and 5.02)
	Set protection	OFF	OFF	OFF	OFF		7 E measurement value for indication and display
	Save User Setup	OFF	OFF	OFF	OFF		
	Alarm Sensors	OFF	OFF	OFF	OFF		
	Limit	.---	.---	OFF	.---		
	Msc0.	OFF	OFF	OFF	OFF		
	ON Value Group2	.---	.---	.---	.---		
	nminm bei Gruppe2	.---	.---	.---	.---		
	Val>Set = n+	ON	ON	ON	ON		
	Type of control	P	P	P	P		
	KP	50%	50%	50%	50%		
	KI	50%	50%	50%	50%		
KD	50%	50%	50%	50%			
TI	0%	0%	0%	0%			

	3.01	3.02	3.03	3.04		
IO Setup	A1 Function	2A	2A	2A	2A	
	A1 min.	0.0 V	0.0 V	0.0 V	0.0 V	A1 / A2 Function
	A1 max.	10.0 V	10.0 V	10.0 V	10.0 V	1 A Constant voltage + 10V
	A1 Inverting	OFF	OFF	OFF	OFF	2 A proportional modulation
	A2 Function	1A	1A	6A	1A	3 A proportional signal E1
	A2 min.	0.0 V	0.0 V	0.0 V	0.0 V	4 A proportional signal E2
	A2 max.	10.0 V	10.0 V	10.0 V	10.0 V	5 A Group control
	A2 Inverting	OFF	OFF	OFF	OFF	6 A only 2.03 cooling
	D1 Function	OFF	OFF	OFF	OFF	7 A only 2.03 Heating
	D1 Inverting	.---	.---	.---	.---	
	D2 Function	OFF	OFF	OFF	OFF	D1..D5 Funktion
	D2 Inverting	.---	.---	.---	.---	1 D Enable ON / OFF
	D3 Function	OFF	OFF	OFF	OFF	2 D External fault
	D3 Inverting	.---	.---	.---	.---	3 D Limit ON / OFF
	D4 Function	OFF	OFF	OFF	OFF	4 D Switch over Singnal E1/E2
	D4 Inverting	.---	.---	.---	.---	5 D switch over Setpoint 1 / 2
	D5 Function	OFF	OFF	OFF	OFF	6 D switch over: Set Intern / Extern
	D5 Inverting	.---	.---	.---	.---	7 D Controlling / Manual intern
	E1 Inverting	OFF	OFF	OFF	OFF	8 D switch over: ActualValue > Set = n + / n -
	E2 Inverting	.---	.---	.---	.---	
	K1 Function	1K	1K	1K	1K	K1..K4 Funktion
	K1 Inverting	OFF	OFF	OFF	OFF	1 K Operation indication
	K2 Function	2K	2K	2K	2K	2 K Fault indication
	K2 Inverting	OFF	OFF	OFF	OFF	3 K external fault
BUS Address	247	247	247	247	4 K Limit modulation	
Level. Function	OFF	OFF	OFF	OFF	5 K Limit E1	
Level min.	.---	.---	.---	.---	6 K Limit E2	
Level max.	.---	.---	.---	.---	7 K Setpoint Offset	
Level Delay	.---	.---	.---	.---	8 K Group control	
Lmt E1 Function	OFF	OFF	1L	OFF	9 K only 2.03 heating funktion	
Lmt E1 min.	.---	.---	0.0°C	.---	10 K only 2.03 cooling funktion	
Lmt E1 max.	.---	.---	40.0°C	.---		
Lmt E1 Hyst.	.---	.---	1.0K	.---		
Lmt E1 Delay	.---	.---	2sec	.---		
Lmt E2 Function	.---	.---	.---	.---	Limits (Lmt. Function)	
Lmt E2 min.	.---	.---	.---	.---	1 L Indication with centralized fault	
Lmt E2 max.	.---	.---	.---	.---	2 L Indication as message	
Lmt E2 Hyst.	.---	.---	.---	.---		
Lmt E2 Delay	.---	.---	.---	.---		
Offset Function	OFF	OFF	OFF	OFF		
Offset 1	.---	.---	.---	.---		
Offset 2	.---	.---	.---	.---		
Offset Hyst.	.---	.---	.---	.---		
Offset Delay	.---	.---	.---	.---		
Timer	Time	13:25	13:25	13:25	13:25	
	Date	18.07 05	18.07 05	18.07 05	18.07 05	
	Summertime Auto.	OFF	OFF	OFF	OFF	
	Timer Function	OFF	OFF	OFF	OFF	
	Mon					
	Mon ON1	↔	↔	↔	↔	
	Mon OFF1	↔	↔	↔	↔	
	Mon ON2	↔	↔	↔	↔	
Mon OFF2	↔	↔	↔	↔		

Diagnostics Menu see chapter 16

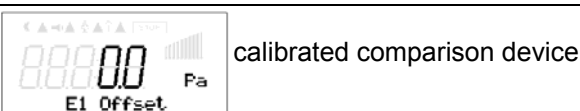
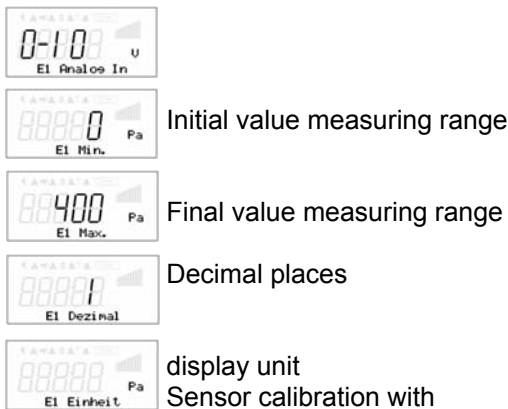
9.4 Pressure control for ventilation systems 4.01-4.03

9.4.1 Basic setting 4.01-4.03



Analog In E1 factory setting to DSG200
 Selection sensor measuring range: DSG 50, *DSG100, DSG200, *DSG300, DSG500, DSG1000, DSG2000, DSG4000, DSG6000
 (* no Ziehl-Abegg standard type)

For sensors with 0-20 mA, 4-20 mA signal put Jumper accordingly and select measuring range DSG50 .. DSG6000.
 For not preprogrammed measuring range the sensor measurement range must be entered in order to display the actual value correctly.
 Example with a 0-10 V sensor and 0-400 Pa measurement range (proportional output signal)



Function Analog Input 2



- External setpoint = Function 1E by external signal (0-10 V) instead of „Setpoint 1“
 0-10 V ^ sensor measuring range
- External manual operation via external signal (0-10V) = function 2E
 Switch over between settings on the device and external manual operation via digital input (☞ IO Setup).
- Measurement value = function 7E
 e.g. for limit indication, display in Info menu “E2 actual”
- Modes with two sensors
 The function is automatically jointly programmed in operating modes using 2 sensors. The second analog input is thus allocated and additional function allocations are not possible.

4.02

E2 Function at 6E preprogrammed = sensor for setpoint lowering.
 preprogrammed sensor type TF..

9.4.2 Setting for operation modes 4.01 and 4.02

4.01 pressure control, setpoint in Pa

4.02 Pressure control for ventilation systems setpoint depending on outdoor temperature Setpoint in Pa (hPa, mbar) and temperature in °C.



↓P ↑ESC



Setpoint 1
Setting range:
in measuring range of sensor

↓ ↑



Setpoint 2
Switch over 1/2 by external contact
IO Setup

↓ ↑



Control range „Pband“
small range = great amplification
and short control time
Big range = longer control times
(higher controller stability)

↓ ↑



Minimal speed
0-100 %

↓ ↑



Maximal speed
100% - Min.

↓ ↑



OFF = automatic control
ON = manual speed setting
0 - 100 %

↓ ↑



Manual speed setting
0 - 100 % if manual mode = ON

Additional menu item for mode 4.02 with outside-temperature dependent target-setpoint

An outside temperature compensation can be activated (sensor connection E2 to analog IN 2) when being operated as a pressure regulation device. An optimal building climate, e.g., can be achieved through this. Through this function, the set and active Setpoint1/2 is automatically changed proportional to the measured outside temperature (Info: "Setpoint control").



Temperature range in which the setpoint change continuously with outside temperature

↓ ↑

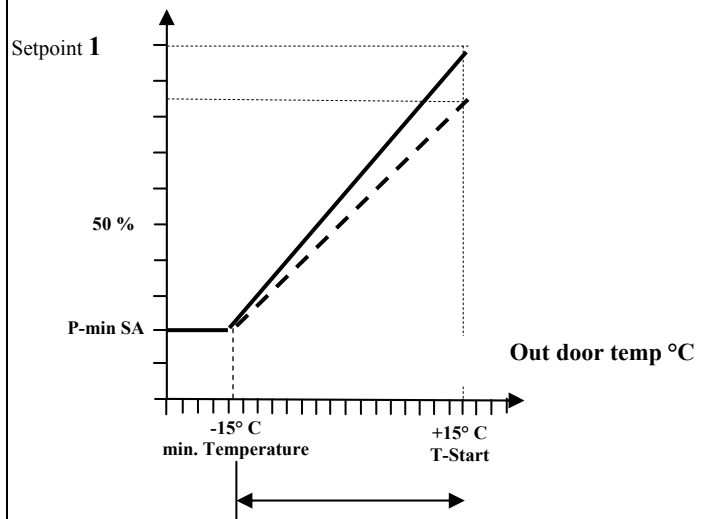


Setpoint reducing will start below this outside temperature (start point)

↓ ↑



Minimum pressure for very low outside temperature



9.4.3 Menu for pressure control airconditioning **4.01** ..**4.02**

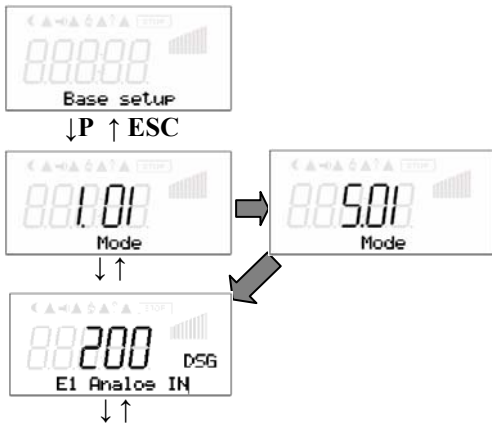
	Parameter	factory setting		User Setting	
S Start	PIN Input	.----	.----		
	Language	GB	GB		
	Reset	OFF	OFF		only display
	Mode	4.01	4.02		
	Unicon	1.06	1.06		
I Info	E1 Actual	88.7 Pa	88.7 Pa		
	E2 Actual	.----	21.0 °C		
	Setpoint 1	100.0 Pa	100.0 Pa		
	Setpoint control		100.0 Pa		
	Fanlevel	0	0		
	Msc.	OFF	OFF		
	Time	12:06	12:06		
	Date	18.07 05	18.07 05		
S Setting	Setpoint 1	100.0 Pa	100.0 Pa		
	Setpoint 2	.----	.----		
	Pband	100.0 Pa	100.0 Pa		
	Min. Speed	0%	0%		
	Max. Speed	100%	100%		
	Manual mode	OFF	OFF		
	Speed manual	100%	100%		
	T-Band SD		30.0 K		
	T-Start SD		15.0°C		
P-Min SD		70.0 Pa			
E Events	External Error	*	*		
	Sensor 1	*	*		
INSTALLATION					
B Base setup	Mode	4.01	4.02		4.01 Pressure control airconditioning
	E1 Analog IN	200 DSG	200 DSG		
	E1 Min.	.----	.----		4.02 Pressure control depending on outdoor temperature
	E1 Max.	.----	.----		
	E1 Decimals	.----	.----		
	E1 unit	.----	.----		
	E1 Offset	0.0 Pa	0.0 Pa		
	E2 Function	OFF	6 E		
	E2 Analog IN	.----	TF		
	E2 Min.	.----	.----		
	E2 Max.	.----	.----		
	E2 Decimals	.----	.----		
	E2 unit	.----	.----		
	E2 Offset	.----	0.0 K		
					E2 Function
					1E 0-10 V external Setpoint
					2E external manual mode
					3E Sensor average to E1
					4E Sensor comparison to E1
					5E Sensor difference to E1
					6E Sensor for setpoint lowering
					(only for mode 4.02 and 5.02)
					7 E measurement value for indication and display
C Controller Setup	PIN Protection	OFF	OFF		
	Set protection	OFF	OFF		
	Save User Setup	OFF	OFF		
	Alarm Sensors	OFF	OFF		
	Limit	.----	.----		
	Msc.	OFF	OFF		
	ON Value Group2	.----	.----		
	nminm bei Gruppe2	.----	.----		
	Val>Set = n+	OFF	OFF		
	Type of control	Pid	Pid		
	KP	50%	50%		
	KI	50%	50%		
	KD	50%	50%		
TI	0%	0%			

	4.01	4.02	User Setting		
IO Setup	A1 Function	2A	2A		
	A1 min.	0.0 V	0.0 V		
	A1 max.	10.0 V	10.0 V		
	A1 Inverting	OFF	OFF		
	A2 Function	1A	1A		
	A2 min.	0.0 V	0.0 V		
	A2 max.	10.0 V	10.0 V		
	A2 Inverting	OFF	OFF		
	D1 Function	OFF	OFF		
	D1 Inverting	.----	.----		
	D2 Function	OFF	OFF		
	D2 Inverting	.----	.----		
	D3 Function	OFF	OFF		
	D3 Inverting	.----	.----		
	D4 Function	OFF	OFF		
	D4 Inverting	.----	.----		
	D5 Function	OFF	OFF		
	D5 Inverting	.----	.----		
	E1 Inverting	OFF	OFF		
	E2 Inverting	.----	.----		
K1 Function	1K	1K			
K1 Inverting	OFF	OFF			
K2 Function	2K	2K			
K2 Inverting	OFF	OFF			
BUS Address	247	247			
Limits	Level. Function	OFF	OFF		
	Level min.	.----	.----		
	Level max.	.----	.----		
	Level Delay	.----	.----		
	Lmt E1 Function	OFF	OFF		
	Lmt E1 min.	.----	.----		
	Lmt E1 max.	.----	.----		
	Lmt E1 Hyst.	.----	.----		
	Lmt E1 Delay	.----	.----		
	Lmt E2 Function	.----	.----		
	Lmt E2 min.	.----	.----		
	Lmt E2 max.	.----	.----		
	Lmt E2 Hyst.	.----	.----		
	Lmt E2 Delay	.----	.----		
	Offset Function	OFF	OFF		
	Offset 1	.----	.----		
	Offset 2	.----	.----		
	Offset Hyst.	.----	.----		
	Offset Delay	.----	.----		
	Timer	Time	13:25	13:25	
Date		18.07 05	18.07 05		
Summertime Auto.		OFF	OFF		
Timer Function		OFF	OFF		
Mon					
Mon ON1		--:--	--:--		
Mon OFF1		--:--	--:--		
Mon ON2		--:--	--:--		
Mon OFF2	--:--	--:--			

Diagnostics Menu see chapter 16

9.5 Volume control **5.01**, **5.02**

9.5.1 Basic setting **5.01**, **5.02**





For all modes in group 5 (**5.01** and **5.02**)
Analog In E1 factory setting to DSG200

Selection sensor measuring range: **DSG 50**, ***DSG100**
DSG200, ***DSG300**, **DSG500**, **DSG1000**, **DSG2000**,
DSG4000, **DSG6000**

(* no Ziehl-Abegg standard type)

For sensors with 0-20 mA, 4-20 mA signal put Jumper accordingly and select measuring range **DSG50** .. **DSG6000**.

 Input of the K of factor dependent on the fan (inlet duct) setting range 0..7.000

 Sensor calibration with calibrated comparison device

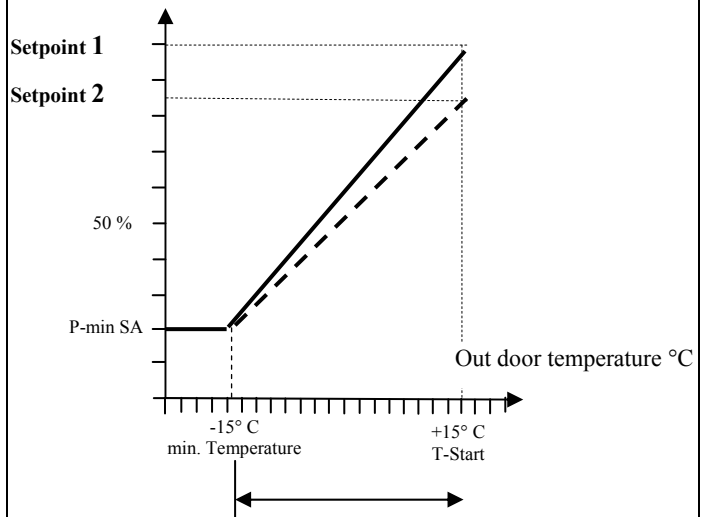
Function Analog Input 2



- External setpoint = Function **1E** by external signal (0-10 V) instead of „Setpoint 1“
0-10 V $\hat{=}$ 0-100 % setting range
- External manual operation via external signal (0-10V) = function **2E**
Switch over between settings on the device and external manual operation via digital input (☞ IO Setup).
- Measurement value = function **7E**
e.g. for limit indication, display in Info menu “E2 actual”
- Modes with two sensors
The function is automatically jointly programmed in operating modes using 2 sensors. The second analog input is thus allocated and additional function allocations are not possible.

5.02

E2 Function at **6E** preprogrammed = sensor for setpoint lowering. Pre-programmed sensor type TF....



9.5.2 Setting for operation modes 5.01 and 5.02

5.01 Volume control, Setpoint in m3/h (m3/s)

5.02 Volume control for ventilation systems setpoint depending on outdoor temperature Setpoint in Pa (hPa, mbar) and temperature in °C.

↓ ↑ ESC

Setpoint 1
Setting range:
in measuring range of sensor and
"K" factor

↓ ↑

Setpoint 2
Switch over 1/2 by external contact
(☞ IO Setup)

↓ ↑

Control range „Pband“
small range = short control time
Big range = longer control times
(higher controller stability)

↓ ↑

Minimal speed
0-100 %

↓ ↑

Maximal speed
100% - Min.

↓ ↑

OFF = automatic control
ON = manual speed setting 0 - 100 %

↓ ↑

Manual speed setting
0 - 100 % if manual mode = ON

Additional menu item for mode 5.02 with outside-temperature dependent target-setpoint

An outside temperature compensation can be activated (sensor connection E2 to analog IN 2) when being operated as a pressure regulation device. An optimal building climate, e.g., can be achieved through this. Through this function, the set and active Setpoint1/2 is automatically changed proportional to the measured outside temperature (☞ Info: "Setpoint control").

↓ ↑

Temperature range in which the
setpoint change continuously with
outside temperature

↓ ↑

Setpoint reducing will start below
this outside temperature (start
point)

↓ ↑

Minimum air volume for very low
outside temperature

9.5.3 Menu for air volume control 5.01 ..5.02

	Parameter	factory setting	User Setting	
Start	PIN Input	.----	.----	
	Language	GB	GB	
	Reset	OFF	OFF	only display
	Mode	5.01	5.02	
	Unicon	1.06	1.06	
Info	E1 Actual	712 m3h	712 m3h	
	E2 Actual	.----	21.0 °C	
	Setpoint 1	530m3h%	530m3h%	
	Setpint control		530m3h%	
	Fanlevel	0	0	
	Msc0.	OFF	OFF	
	Time	12:06	12:06	
	Date	18.07 05	18.07 05	
Setting	Setpoint 1	530m3h	530m3h	
	Setpoint 2	.----	.----	
	Pband	530m3h	530m3h	
	Min. Speed	0%	0%	
	Max. Speed	100%	100%	
	Manual mode	OFF	OFF	
	Speed manual	100%	100%	
	T-Band SD		30.0 K	
	T-Start SD		15.0°C	
P-Min SD		70.0 Pa		
Events	External Error	*	*	
	Sensor 1	*	*	
INSTALLATION				
Base setup	Mode	5.01	5.02	5.01 Volume control (constant) for ventilation systems
	E1 Analog IN	200 DSG	200 DSG	
	E1 K-Factor	75	75	
	E1 Min.	.----	.----	5.02 Volume control depending on outdoor temperature
	E1 Max.	.----	.----	
	E1 Decimals	.----	.----	
	E1 unit	.----	.----	
	E1 Offset	0 m3h	0 m3h	
	E2 Function	OFF	6 E	
	E2 Analog IN	.----	TF	
	E2 K-Factor	.----		
	E2 Min.	.----	.----	
	E2 Max.	.----	.----	
	E2 Decimals	.----	.----	
E2 unit	.----	.----		
E2 Offset	.----	0.0 K		
Controller Setup	PIN Protection	OFF	OFF	
	Set protection	OFF	OFF	
	Save User Setup	OFF	OFF	
	Alarm Sensors	OFF	OFF	
	Limit	.----	.----	
	Msc0.	OFF	OFF	
	ON Value Group2	.----	.----	
	nminm bei Gruppe2	.----	.----	
	Val>Set = n+	OFF	OFF	
	Type of control	Pid	Pid	
	KP	50%	50%	
	KI	50%	50%	
	KD	50%	50%	
	TI	0%	0%	

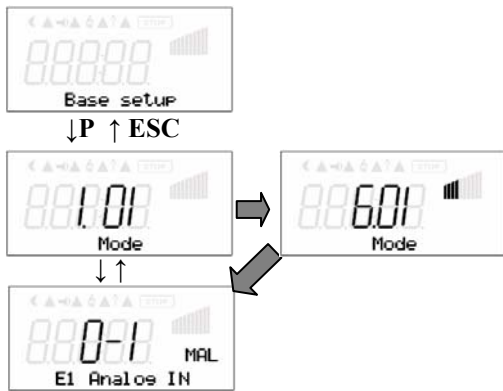
E2 Function	
1E	0-10 V external Setpoint
2E	external manual mode
3E	Sensor average to E1
4E	Sensor comparison to E1
5E	Sensor difference to E1
6E	Sensor for setpoint lowering
7 E	measurement value for indication and display

	5.01	5.02	User Setting				
IO Setup	A1 Function	2A	2A				
	A1 min.	0.0 V	0.0 V		A1 / A2 Function		
	A1 max.	10.0 V	10.0 V		1 A	Constant voltage + 10V	
	A1 Inverting	OFF	OFF		2 A	proportional modulation	
	A2 Function	1A	1A		3 A	proportional signal E1	
	A2 min.	0.0 V	0.0 V		4 A	proportional signal E2	
	A2 max.	10.0 V	10.0 V		5 A	Group control	
	A2 Inverting	OFF	OFF		6 A	only 2.03 cooling	
	D1 Function	OFF	OFF		7 A	only 2.03 Heating	
	D1 Inverting	.----	.----				
	D2 Function	OFF	OFF		D1..D5 Funktion		
	D2 Inverting	.---	.---		1 D	Enable ON / OFF	
	D3 Function	OFF	OFF		2 D	External fault	
	D3 Inverting	.---	.---		3 D	Limit ON / OFF	
	D4Function	OFF	OFF		4 D	Switch over Singnal E1/E2	
	D4 Inverting	.---	.---		5 D	switch over Setpoint 1 / 2	
	D5 Function	OFF	OFF		6 D	switch over:Set Intern / Extern	
	D5 Inverting	.---	.---		7 D	Controlling / Manual intern	
	E1 Inverting	OFF	OFF		8 D	switch over:ActualValue>Set=n+/n-	
	E2 Inverting	.---	.---				
	K1 Function	1K	1K		K1..K4 Funktion		
	K1 Inverting	OFF	OFF		1 K	Operation indication	
	K2 Function	2K	2K		2 K	Fault indication	
	K2 Inverting	OFF	OFF		3 K	external fault	
	BUS Address	247	247		4 K	Limit modulation	
	Limits	Level. Function	OFF	OFF	5 K	Limit E1	
		Level min.	.---	.---	6 K	Limit E2	
Level max.		.---	.---	7 K	Setpoint Offset		
Level Delay		.---	.---	8 K	Group control		
Lmt E1 Function		OFF	OFF	9 K	only 2.03 heating funktion		
Lmt E1 min.		.---	.---	10 K	only 2.03 cooling funktion		
Lmt E1 max.		.---	.---				
Lmt E1 Hyst.		.---	.---				
Lmt E1 Delay		.---	.---				
Lmt E2 Function		.---	.---		Limits (Lmt. Function)		
Lmt E2 min.		.---	.---	1 L	Indication with centralized fault		
Lmt E2 max.		.---	.---	2 L	Indication as message		
Lmt E2 Hyst.		.---	.---				
Lmt E2 Delay		.---	.---				
Offset Function		OFF	OFF				
Offset 1		.---	.---				
Offset 2		.---	.---				
Offset Hyst.		.---	.---				
Offset Delay		.---	.---				
Timer		Time	13:25	13:25			
	Date	18.07 05	18.07 05				
	Summertime Auto.	OFF	OFF				
	Timer Function	OFF	OFF				
	Mon						
	Mon ON1	:-	:-				
	Mon OFF1	:-	:-				
	Mon ON2	:-	:-				
Mon OFF2	:-	:-					

Diagnostics Menu see chapter 16

9.6 Air velocity control 6.01

9.6.1 Basic setting 6.01



For mode 6.01 E1 factory setting to MAL1 selection sensor measuring range: MAL1, MAL 10

Alternative selection signal: 0-10 V, 0-20 mA, 4-20 mA, jumper accordingly inserted.
The sensor measurement range must be entered in order to display the actual value correctly. Example with a 0-10 V sensor and 0-100° C measurement range



Initial value measuring range



Final value measuring range



Decimal places



display unit



Sensor calibration with calibrated comparison device

Funktion analog Eingang 2

- External setpoint = Function 1E by external signal (0-10 V) instead of „Setpoint 1“
0-10 V $\hat{=}$ 0-100 % setting range
- External manual operation = function 2E via external signal (0-10V).
Switch over between settings on the device and external manual operation via digital input (IO Setup).
- Measurement value = function 7E
e.g. for limit indication, display in Info menu “E2 actual”.

9.6.2 Settings for operation modes 6.01



↓P ↑ESC



Setpoint 1
Setting range:
in measuring range of sensor



Setpoint 2
Switch over 1/2 by external contact
IO Setup



Control range „Pband“
small range = short control time
Big range = longer control times (higher controller stability)



Minimal speed
0-100 %



Maximal speed
100% - Min.



OFF = automatic control
ON = manual speed setting 0 - 100 %




















Manual speed setting
0 - 100 % if manual mode = ON

9.6.3 Menu for air velocity control **6.01**

	Parameter	factory setting	User Setting				
Start	PIN Input	.----					
	Language	GB					
	Reset	OFF			only display		
	Mode	6.01					
	Unicon	1.06					
In fo	E1 Actual	0.45m/s					
	E2 Actual	.----					
	Setpoint 1	0.50m/s					
	Fanlevel	0					
	Msc0.	OFF					
	Time	12:06					
	Date	18.07 05					
Setting	Setpoint 1	0.50m/s					
	Setpoint 2	.----					
	Pband	0.50m/s					
	Min. Speed	0%					
	Max. Speed	100%					
	Manual mode	OFF					
	Speed manual	100%					
Events	External Error	*					
	Sensor 1	*					
INSTALLATION							
Base setup	Mode	6.01		6.01	Air velocity control		
	E1 Analog IN	0-1 MAL					
	E1 Min.	.----					
	E1 Max.	.----					
	E1 Decimals	.----					
	E1 unit	.----					
	E1 Offset	0.00 m/s					
	E2 Function	OFF					
	E2 Analog IN	.----			E2 Function		
	E2 Min.	.----			1E	0-10 V external Setpoint	
	E2 Max.	.----			2E	external manual mode	
	E2 Decimals	.----			3E	Sensor average to E1	
	E2 unit	.----			4E	Sensor comparison to E1	
	E2 Offset	.----			5E	Sensor difference to E1	
Controller Setup	PIN Protection	OFF		6E	Sensor for setpoint lowering		
	Set protection	OFF			only for mode 4.02 and 5.02)		
	Save User Setup	OFF		7 E	measurement value for indication and display		
	Alarm Sensors	OFF					
	Limit	.----					
	Msc0.	OFF					
	ON Value Group2	.----					
	nminm bei Gruppe2	.----					
	Val>Set = n+	OFF					
	Type of control	Pid					
	KP	50%					
	KI	50%					
	KD	50%					
TI	0%						

		5.01					
IO Setup	A1 Function	2A					
	A1 min.	0.0 V			A1 / A2 Function		
	A1 max.	10.0 V			1 A	Constant voltage + 10V	
	A1 Inverting	OFF			2 A	proportional modulation	
	A2 Function	1A			3 A	proportional signal E1	
	A2 min.	0.0 V			4 A	proportional signal E2	
	A2 max.	10.0 V			5 A	Group control	
	A2 Inverting	OFF			6 A	only 2.03 cooling	
	D1 Function	OFF			7 A	only 2.03 Heating	
	D1 Inverting	.----					
	D2 Function	OFF			D1..D5 Funktion		
	D2 Inverting	.----			1 D	Enable ON / OFF	
	D3 Function	OFF			2 D	External fault	
	D3 Inverting	.----			3 D	Limit ON / OFF	
	D4Function	OFF			4 D	Switch over Singnal E1/E2	
	D4 Inverting	.----			5 D	switch over Setpoint 1 / 2	
	D5 Function	OFF			6 D	switch over:Set Intern / Extern	
	D5 Inverting	.----			7 D	Controlling / Manual intern	
	E1 Inverting	OFF			8 D	switch over:ActualValue>Set=n+/n-	
	E2 Inverting	.----					
	K1 Function	1K			K1..K4 Funktion		
	K1 Inverting	OFF			1 K	Operation indication	
	K2 Function	2K			2 K	Fault indication	
	K2 Inverting	OFF			3 K	external fault	
	BUS Address	247			4 K	Limit modulation	
Level. Function	OFF			5 K	Limit E1		
Level min.	.----			6 K	Limit E2		
Level max.	.----			7 K	Setpoint Offset		
Level Delay	.----			8 K	Group control		
Lmt E1 Function	OFF			9 K	only 2.03 heating funktion		
Lmt E1 min.	.----			10 K	only 2.03 cooling function		
Lmt E1 max.	.----						
Lmt E1 Hyst.	.----						
Lmt E1 Delay	.----						
Lmt E2 Function	.----			Limits (Lmt. Function)			
Lmt E2 min.	.----			1 L	Indication with centralized fault		
Lmt E2 max.	.----			2 L	Indication as message		
Lmt E2 Hyst.	.----						
Lmt E2 Delay	.----						
Offset Function	OFF						
Offset 1	.----						
Offset 2	.----						
Offset Hyst.	.----						
Offset Delay	.----						
Timer	Time	13:25					
	Date	18.07 05					
	Summertime Auto.	OFF					
	Timer Function	OFF					
	Mon						
	Mon ON1	--:					
	Mon OFF1	--:					
	Mon ON2	--:					
Mon OFF2	--:						

Diagnostics Menu see chapter 16

<p>10. Menu group Start</p> 	<p>11. Menu group Info</p> 
 <p>The service menu for the installation can be protected against unintentional changes by a pin code. With further pin codes putting back to pre-setting is possible.</p> <p>PIN 0010 Opening service menu, if PIN-protection activated</p> <p>PIN 1234 opening "setting", if "set protection" ON (☞ Controller Setup)</p> <p>PIN 9090 Restore user setting</p> <p>PIN 9091 Save user setting (corresponds function "Save user setup ON" ☞ Controller Setup)</p> <p>PIN 9095 Restore factory setting = delivery status</p>  <p>Example for PIN input 0010 for opening service menu</p>  <p>Menu language by the factory set to English. In this menu different national languages can be selected (GB = English, D = Deutsch ...).</p>  <p>Complete re-start of the device.</p>  <p>Query of the operating mode</p>  <p>Query of the device software version</p>	<p>For mode speed controller 1.01</p>  <p>Modulation of the controller device in addition to the bar display.</p>  <p>Display of the type and level of the active default signal in percent (0-100 % $\hat{=}$ 0-10 V, 10-0 V, 0-20 mA, 20-0 mA, 4-20 mA, 20-4 mA).</p> <p>Display: the device operates at :</p> <p>Set „External 1“ = Signal to „E1“ / „GND“ Set „External 2“ = Signal to „E2“ / „GND“ Set „Intern 1“ = Menu „Set intern 1“ Set „Intern 2“ = Menu „Set intern 2“</p> <p>Info for mode controller 2.01 .., 3.01 .., 4.01 .., 5.01 .., 6.01 ..,</p>  <p>Current actual value measured on the sensor 1. Depending sensor-type, in mbr, m³/s, m/s, Pa, %, bar, m³/h, °C, V, mA, etc.</p>  <p>For operation with two sensors display for „E2 actual“. If function not active, display -----</p> <p>Display of the active target value at which the device operates</p>  <p>„Setpoint 1“ = Menu Setting Setpoint 1</p> <p>„Setpoint 2“ = Menu Setting Setpoint 2</p> <p>„Ext. Setpoint = setting by external signal 0-10 V. With activated manual mode the display constantly changes between actual value and value for "manual mode".</p>  <p>Modulation of the controller device, in addition to the bar display.</p>  <p>Momentarily status for minimum speed cut off Msc0.“ : ON = switch off, if Setpoint (\pm Min. speed cut off) is reached “Msc0“ : OFF = no switch off that means operation with minimum rate of air.</p>  <p>Announcement of the current time</p>  <p>Announcement of the current date</p>

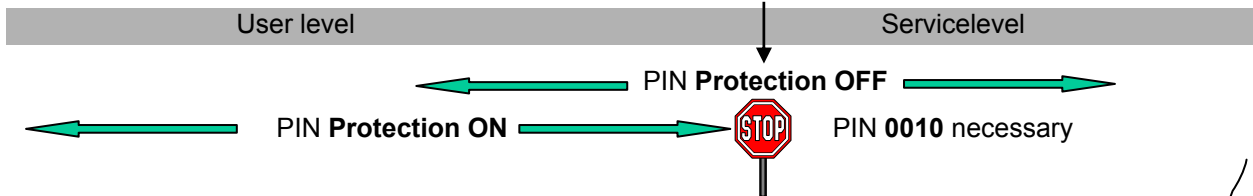
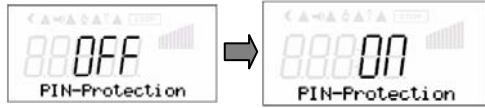
12. Controller Setup



12.1 PIN Protection

The adjustments for the installation in the service level can be protected against unintentional modifications. To do this, activate the „PIN protection“.
In order to simplify the initial start-up operation, the service level in the factory setting is free – i.e. accessible without PIN 0010.

After installation of the device has been carried out, PIN protection should be activated!



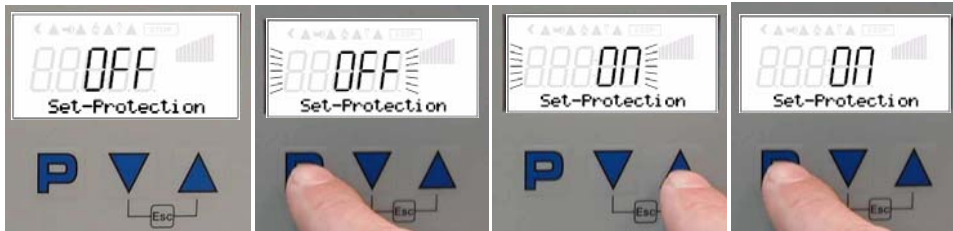
Start	INFO	Setting	Events	Base setup	Controller Setup	IO
----	:	:	:	:	OFF	
PIN Input					PIN-Protection	
:	:	:	:	:		

12.2 Set protection

The „Settings“ menu for the user’s basic settings (Setpoint, default value, min, max ..) are freely accessible when using the factory settings (i.e. without PIN).
If necessary, these can also be protected against unauthorized modifications by using a PIN (1234). For this, the settings protection must be programmed to „ON“. The settings menu is then no longer visible without inputting a PIN!



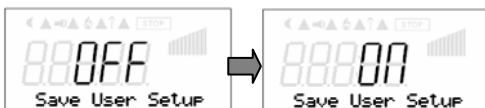
Function only in combination with activated PIN protection!



Menu „Setting“ if Set-protection „ON“ only after PIN Input (1234) visible

Start	INFO	Setting	Events
:	:	:	:

12.3 Save user settings



The individually made device configurations (User Settings) can be saved and, with the corresponding PIN input (9090), can be reestablished (↶ Start → PIN input).



Important information!

By entering PIN 9095 in the „PIN“ menu in the start menu-group, the device is entirely reset to the pre-delivery condition **Any changes that have been made to the settings are thus lost!**

12.4 Sensor Alarm ON / OFF

Function only in controller mode!

For "Analog IN 1" and if activated for sensor 2 Analog IN2. In case of an interruption or short-circuit in the sensor conductor, or in case of measured values that lie outside of the device's measurement range, an error message can occur via the alarm symbol in the display and a relay.



The sensor malfunction indicator is factory set to off so that error messages do not interfere with start-up operations. When the alarm sensors are set to **OFF**, the sensor malfunctions are stored merely for informational purposes as "messages" in "Events".



For Alarm OFF
Message in "Events"



For Alarm ON
Display alternating to actual value

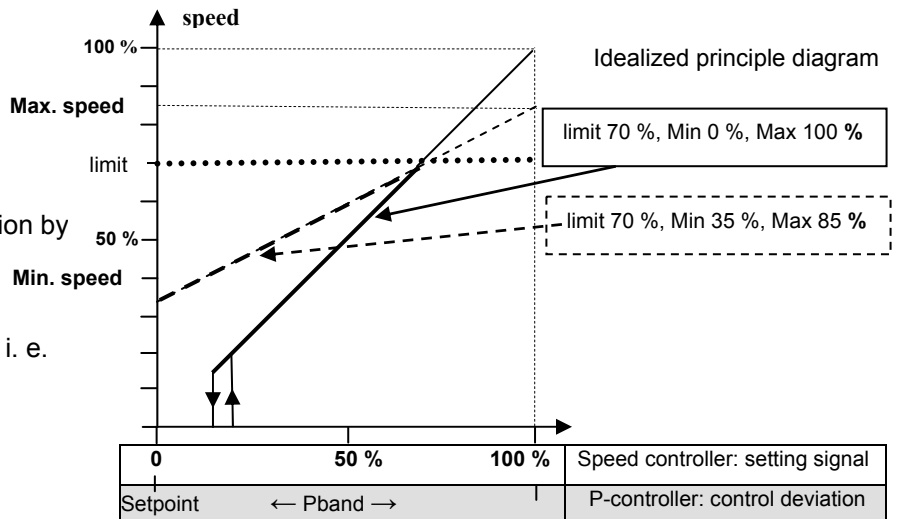
12.5 Limit

An adjustable limitation of the modulation can be activated via a digital input („D1“, „D2“, ..) (depending on the programming, **as long as no allocation is carried out: Display: [----], IO Setup).**

Limit value= max. possible modulation (e.g. speed reduction during night operation by time switch).



Limit value= max. possible modulation (e.g. speed reduction during night operation by time switch).
Setting range Limit „Max. Speed“ up to „Min. Speed“
Factory setting 100 % ^ max. modulation, i. e. no limit.

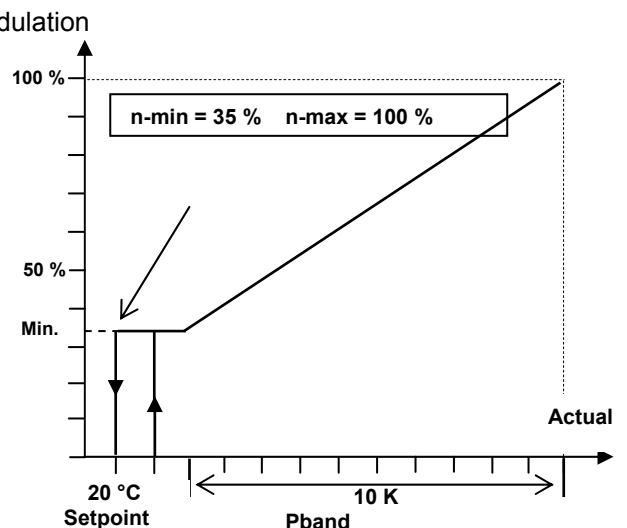


12.6 Minimum speed cut off

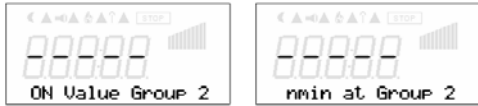
This function is primarily significant for installation of the device as a pure P Controller in refrigeration and air-conditioning technology.

For operation mode speed controller **1.01** without function!

- **Msc0** = **OFF** (factory setting)
If no "Min. speed" is adjusted, the fan stops with reaching modulation desired value.
If "Min. speed" is adjusted (e.g. 20%), then no disconnection of the fan takes place. I.e., always a minimum ventilation is ensured (fan does not go under setting "Min. speed").
- **Msc0** = **ON**
It takes place a disconnection from setting "Min. speed" to "0", if the given difference is reached related to the desired value. At a plus value (+) before reaching the desired value at a minus value (-) after falling below the desired value.



12.7 Second Group



Second group „indirectly controlled“ (picture 1)

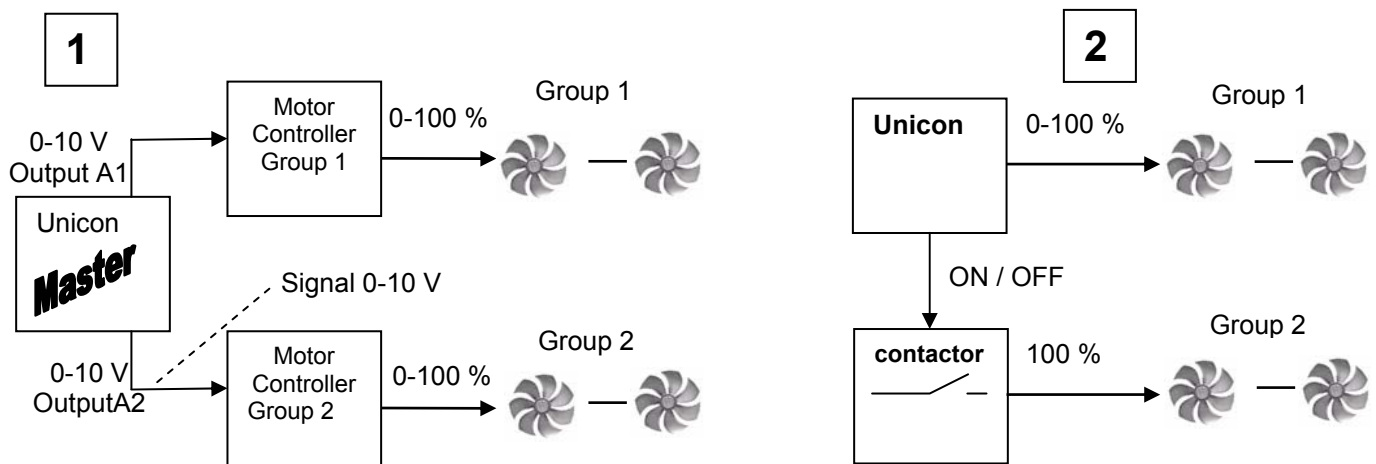
Analog output „Analog OUT 1“ in IO Setup function **5 A** = group control is programmed.

This output is employed as the default signal for a speed controller. If the default signal or the regulation deviation exceeds the group 2 switch-on point, group 1 is reduced to „n-min group 2“. Starting here, both groups run parallel at maximum power.

Second group „100 % energized“ (picture 2)

Relay output (K1 or K2) in IO Setup function **8 K** = group control is programmed.

A contactor is triggered via this relay contact, which directly switches the fans of the second group to mains voltage. If the default signal or the regulation deviation exceeds the „Group 2 ON value“ switch-on point, the relay for the second group switches on and the speed of the first group is lowered to an adjustable minimum value. After that, the speed of the first group increases back up to maximum.



12.8 Reverse action of the control function (actual Value>Set = n+)

For the effect of the regulation there are **TWO** functions

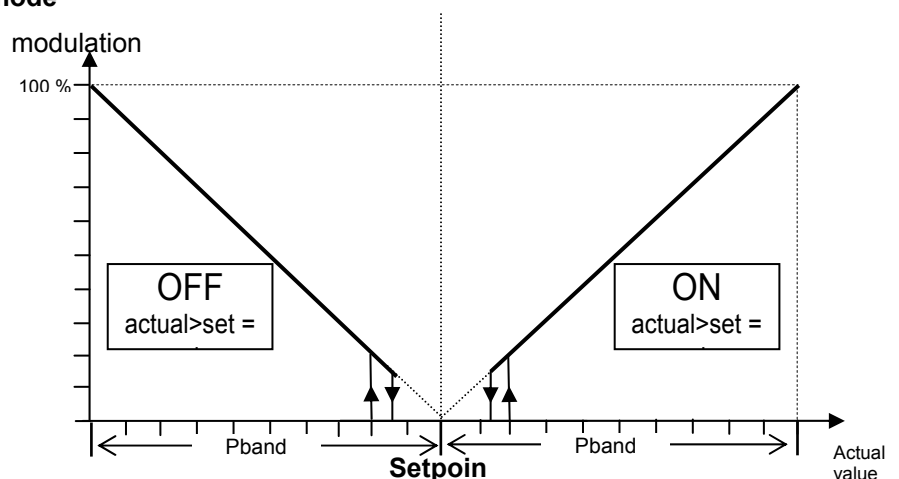
- 1. Setting **ON** for **actual Value>Set = n+ Δ** increasing output voltage at increasing actual value
- 2. Setting **OFF** for **actual Value>Set = n+ Δ** decreasing output voltage at increasing actual value

For special applications an **external switch over of control function is possible** (☞ IO Setup → Reverse for control function).

Factory setting depending on selected mode

Mode	Control function
1.01	No control function
2.01 ..	ON
3.01 ..	ON
4.01 ..	OFF
5.01 ..	OFF
6.01 ..	OFF

Example for temperature control (Idealized principle diagram)



12.9 Controller configuration (controller type) and controller action)

The controller configuration is automatically carried out during selection of the application related mode of operation. The factory presets in accordance with the mode of operation are based on many years of experience, which is suitable for many applications. Under special circumstances, these can be individually adapted.

The **type of control** determines the method with which the controlled value behaves in case of a difference between the target and current values. For this, the control technology has standard algorithms, which consist of a combination of three methods:

Selection P, PID

Pcontrol (**P**roportional component, proportion of the absolute deviation)

Icontrol (**I**ntegral component, proportion of the sum of all deviations)

Dcontrol (**D**ifferential component, proportion of the last difference)

With pure P controllers (controller type P), the following described settings do not have any function!

If needed, the most suitable combination for the respective control system can be determined from these proportions.



➔ P-component = reaction time
Setting range 0-200 %
smaller = more slowly
bigger = faster



➔ I-component = accuracy, correction time
Setting range 0-200 %
smaller = faster
bigger = more slowly



➔ D-component = stability by slower correction time
Setting range 0-200 %
smaller = faster
bigger = more slowly



➔ Integration time = correction time
Setting range 0-200 %
smaller = faster
bigger = more slowly

13.1 Analog Output A (Analog OUT 1)

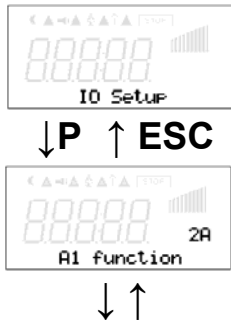
13.1.1 Function analog output A (Analog OUT 1)

The analog outputs 0-10 V can be allocated with various functions.

Den analogen Ausgängen 0-10 V können unterschiedliche Funktionen zugeordnet werden.

Terminals 19 (A1) - 20 (GND) = Analog OUT 1 (I_{max} 10 mA) Pre-setting for speed controller input

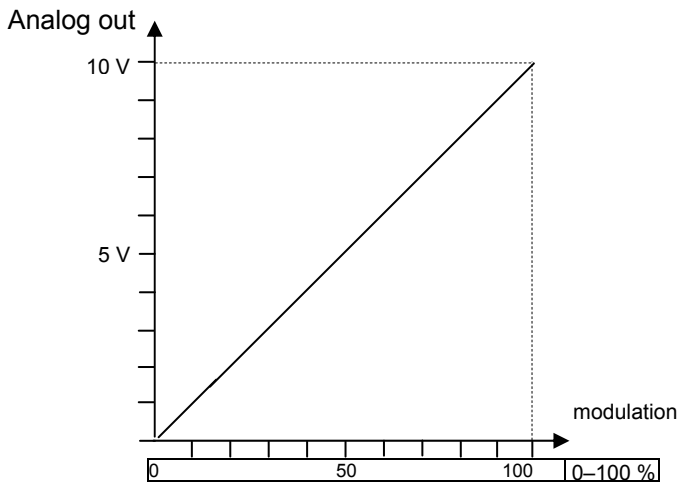
Terminals 21 (A2) - 22 (GND) = Analog OUT 2 (I_{max} 10 mA)



The following functions can be assigned to the output

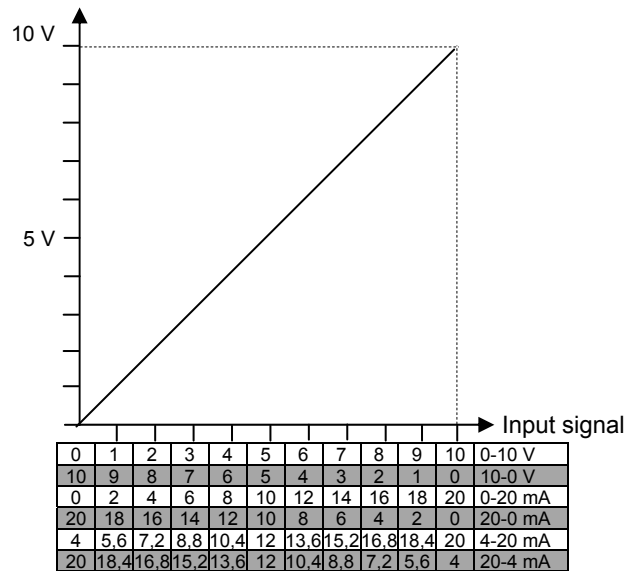
Function	description
OFF	no Function
1 A	Constant voltage +10 V (factory setting for A2, out of 2.03)
2 A	proportional modulation (Factory setting A1)
3 A	proportional input E1
4 A	proportional input E2
5 A	Group control
6 A	Control output 2 increasing modulation at <u>actula value</u> >Set (cooling) (only mode 2.03 temperature controller with additional functions)
7 A	Control output 2 increasing modulation at actual value <Set (Heating) (only mode 2.03 temperature controller with additional functions)

Function 2 A proportional modulation



Idealized principle diagram

Function 3 A / 4 A proportional input signal



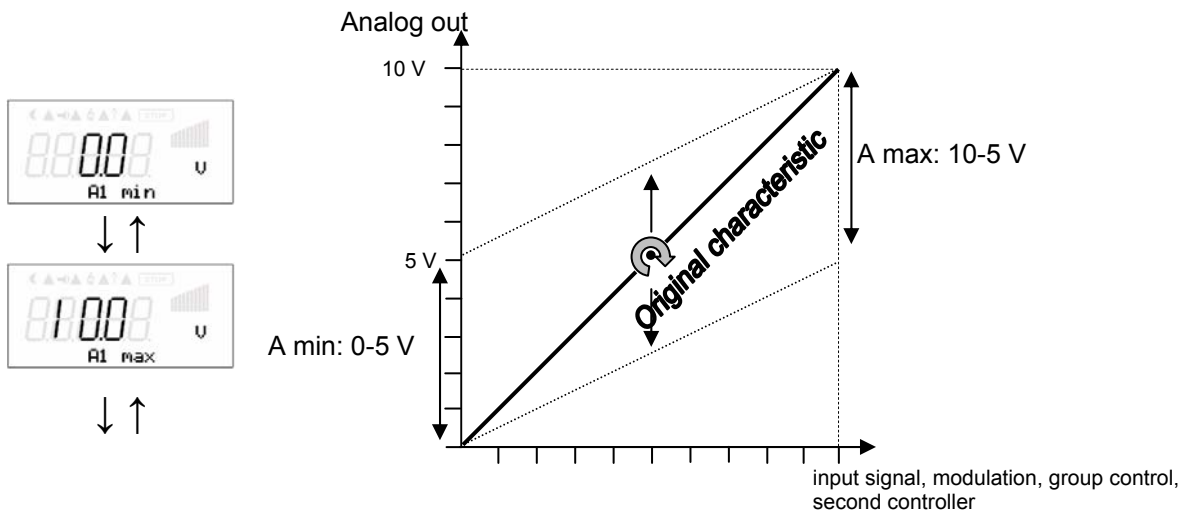
For activ sensors 0-10 V Signal proportional measuring range.
 For passiv temperature sensors type TF.. (KTY10-6) proportional to -25 up to +80° C (↳ 1.303 Ω up to 2.886 Ω).

13.1.2 Adjustment analog output A1 und A2

With the attitudes A1 min or A2 min and A1 max or A2 max the characteristic of the output voltage can be adapted

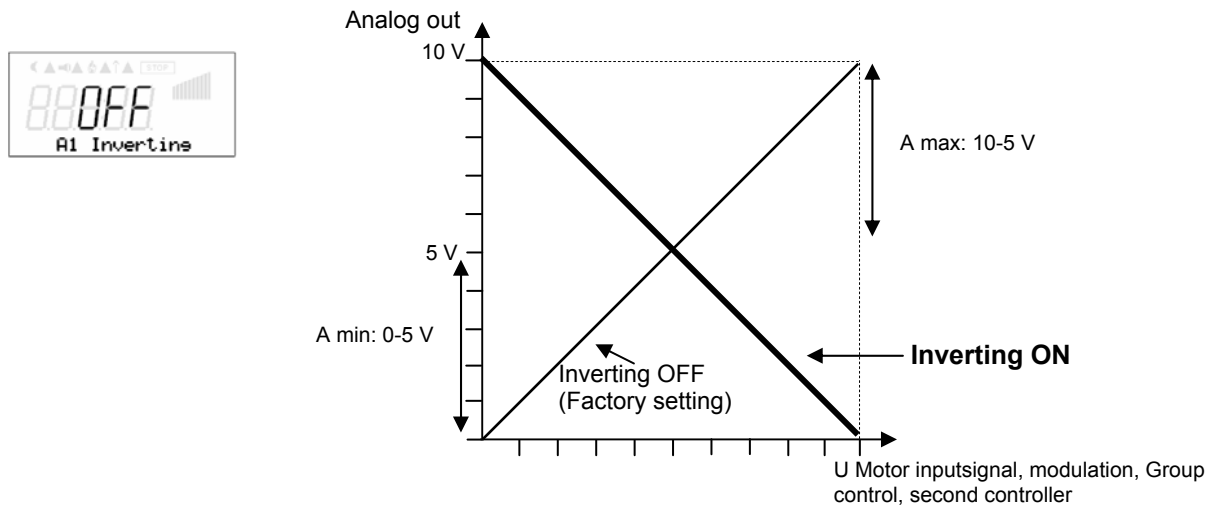
Factory setting: A1 min or A2 min = 0 V, A1 max bzw. A2 max = 10 V

Setting range: A1 min or A2 min = 0-5 V, A1 max bzw. A2 max = 10-5 V



With the attitudes A Inverting the output voltage can be inverted

Factory setting OFF



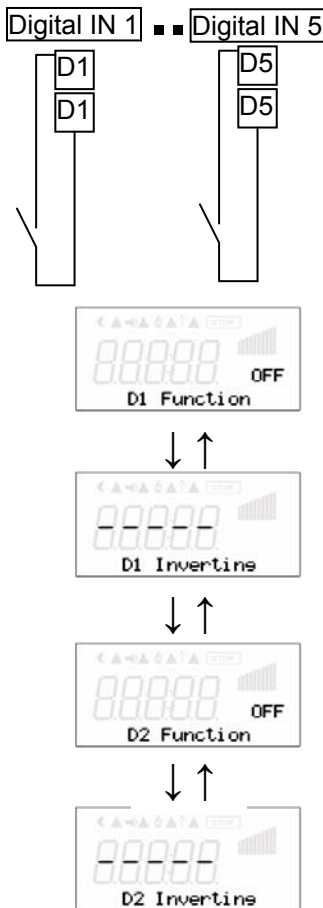
13.2 Functional overview of digital inputs D1 ... D5

The 5 digital inputs Digital IN 1 (D1) to Digital IN 5 (D5) can be allocated with various functions..
Avoid the same function allocation for several Input in order to exclude undefined conditions.

Activation via floating contacts (a low voltage of approx. 24 V DC is connected).

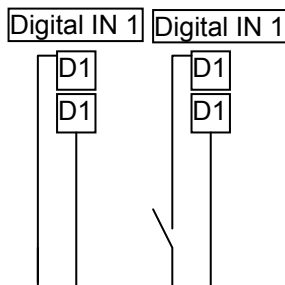
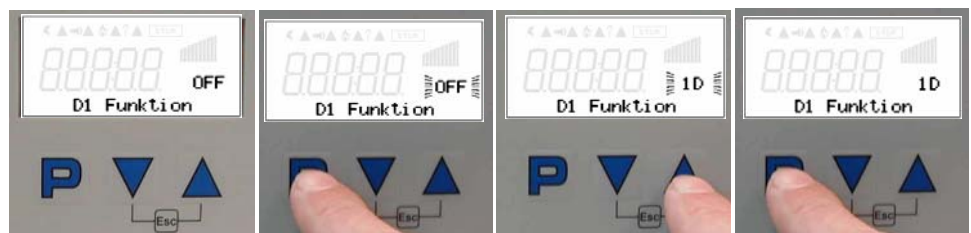


Never apply external voltage to the digital inputs!



Function	description
--	no Function (factory setting) controller reacts neither to opened nor closed contact
1 D	Enable (remote control) ON / OFF Release ON / OFF
2 D	External fault connecting an external alarm indication
3 D	Limit ON / OFF Limitation of max. output voltage
4 D	E1 / E2 Switch over between signal at Analog IN 1 (E1) and Analog IN 2 (E2)
For mode speed controller 1.01	
5 D	Set Intern 1 / 2 Switch over between 2 adjusted settings at the controller
6 D	Intern / Extern Switch over setting at the controller / external signal
For modes as controller (higher 2.01)	
5 D	Setpoint 1 / 2 Switch over between 2 Setpoints (e. g. day- / night operation)
6 D	Intern / Extern Switch over between setting at the controller or external signal
7 D	automatic control / speed manual internal (menu Speed manual) switch over between automatic control and Speed manual
8 D	Switch over between ON: ActualVal>Set =n+ and OFF: Actual>Set=n- Reverse action of control function (e. g. Heating / Cooling)

Example:
Programming D1 (Digital IN 1) for enable controller by floating contact
Function 1D



device ON device OFF

D1 ..D5 Inverting

If D1 or D2 was allocated with a function, the device works factory preset with a non-inverted input **D Inverting OFF**
Not inverted
Device ON with closed contact, device OFF with open contact on terminal D1-D1 (the other way around with inversion – i.e., device OFF with closed contact)

as long as no allocation is carried out: Display: ----

13.2.1 Enable ON / OFF Funktion 1D

Remote ON / OFF (electronic disconnection) contact free of potential, operation of the device is still possible after pressing the “ESC” hotkey combination in switched-off condition. Signal- in and outputs remain active
 A programmed operating indicator relay (factory set K1 function 1K) reports the switch-off.
 A programmed alarm relay (factory set K2 function 2 K) does not report the switch-off.



No disconnection (isolation) when turned off, in accordance with VBG4 §6.

Display **STOP** for switch off by remote switch at digital input e. g. Digital IN 1 = D1-D1

Controller ON for closed contact

D1 Inverting **OFF** D1-D1 bridged =controller ON

Controller ON with opened kontakt

D1 Inverting **ON** D1-D1 open = controller ON

13.2.2 External fault Funktion 2D

Connecting an external alarm indication (via floating contact).



The device continues to work unchanged during an external indication to the digital input; the alarm symbol appears in the display. This indication can be issued via the relay contacts (K1, K2) (☞ IO Setup function K1, K2).

Indication during closed contact (factory preset) **D1 Inverting** **OFF**

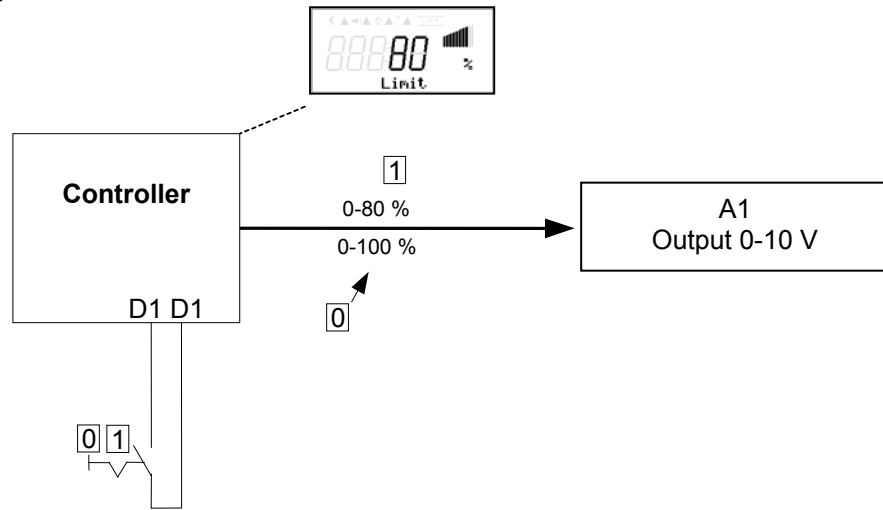
Indication during opened contact **D1 Inverting** **ON**

13.2.3 Limit ON / OFF Funktion 3D

The value for **Limit** adjusted in the Controller Setup, is activated over a digital input („Digital IN 1“ = D1-D5 or Timer function activates).

Limit value = max. possible modulation (e.g. speed reduction during night operation by time switch)

contact at digital inputs e.g. Digital IN 1 = D1-D1



Limit ON (limitation activ) at closed contact (factory setting)

D1 Inverting **OFF**

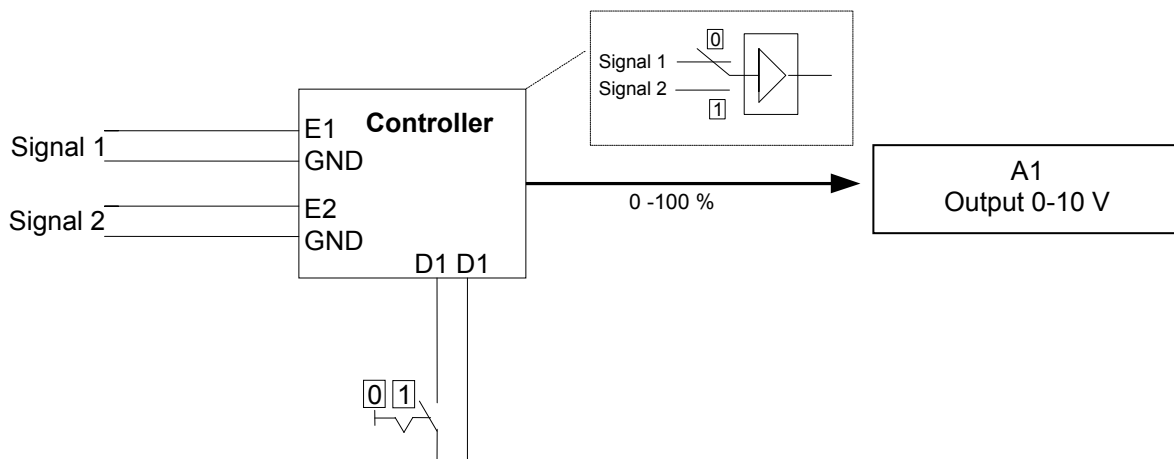
Limit ON (limitation activ) at opened contact

D1 Inverting **ON**

13.2.4 Switch over E1 / E2 Funktion 4D

Switch over between input signal 1 (at Analog IN 1 terminal E1) and input signal 2 (an Analog IN terminal E2)

contact at digital input e. g. Digital IN 1 = D1-D1



Signal from (E1) at opened contact ↔ Signal from “E2“ at closed contact

D1 Inverting **OFF**

Signal from (E1) at closed contact ↔ Signal from “E2“ at opened contact

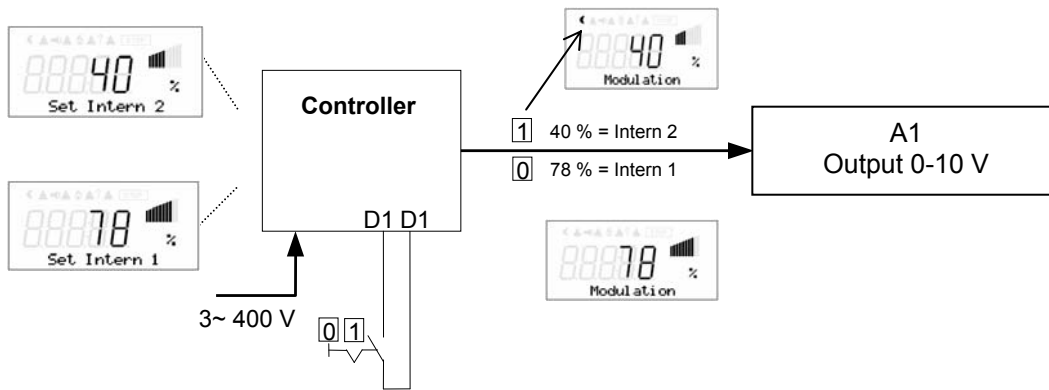
D1 Inverting **ON**

13.2.5 Set Intern 1 / Set Intern 2 or. Setpoint 1/2 **Function 5D**

- ◆ **Switch over between Set Intern 1 and Set Intern 2** (for speed controller **1.01**)
 Operation with "Internal default 2" is signaled by the moon symbol for reduced operation.

"Set external 1" under settings must be programmed to OFF.

contact at digital input e. g. Digital IN 1 = D1-D1

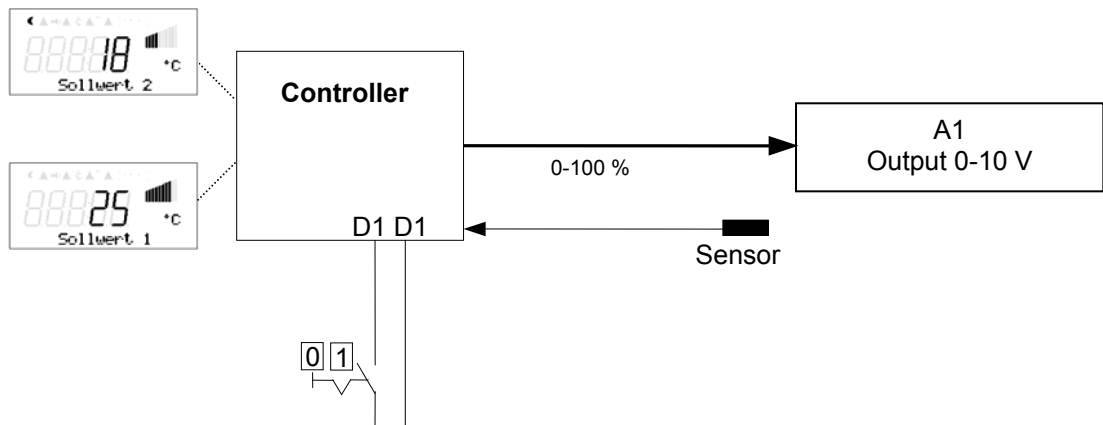


Set Intern 1 at opened contact ↔ Set Intern 2 at closed contact **D1 Inverting** OFF

Set Intern 1 at closed contact ↔ Set Intern 2 at closed contact **D1 Inverting** ON

- ◆ **Switch over between Setpoint 1 and Setpoint 2** (for modes as controller higher **2.01**)
 operation with „Setpoint 2“ is signaled by the moon symbol for reduced operation.

contact at digital input e. g. Digital IN 1 = D1-D1



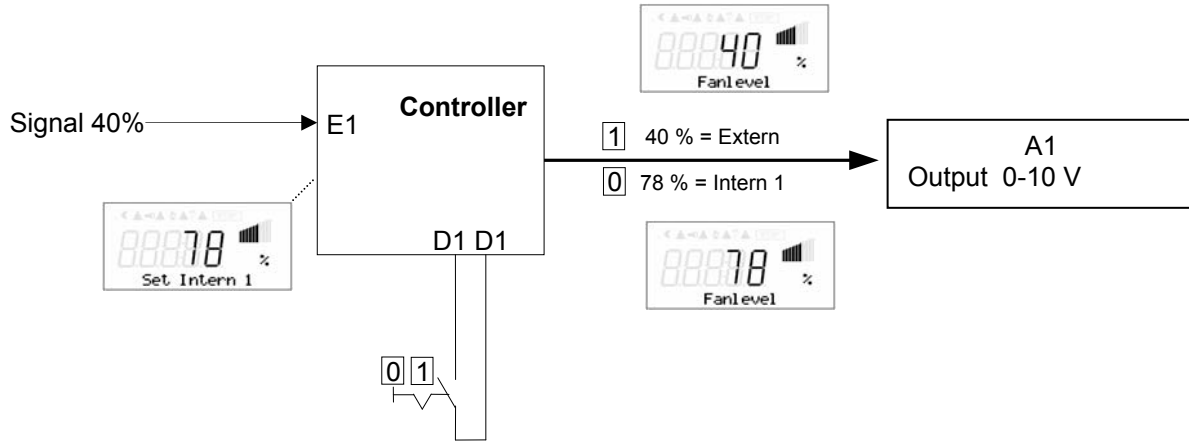
Setpoint 1 = 18° C at opened contact ↔ Setpoint 2 = 25° C at closed contact **D1 Inverting** OFF

Setpoint 1 = 18° C at closed contact ↔ Setpoint 2 = 25° C at opened contact **D1 Inverting** ON

13.2.6 Intern / Extern **Function 6D**

◆ **Switch over between Set Intern and Set Extern** (for mode speed controller **1.01**)

“Set external 1” under settings must be programmed to OFF contact at digital input e. g. Digital IN 1 = D1-D1

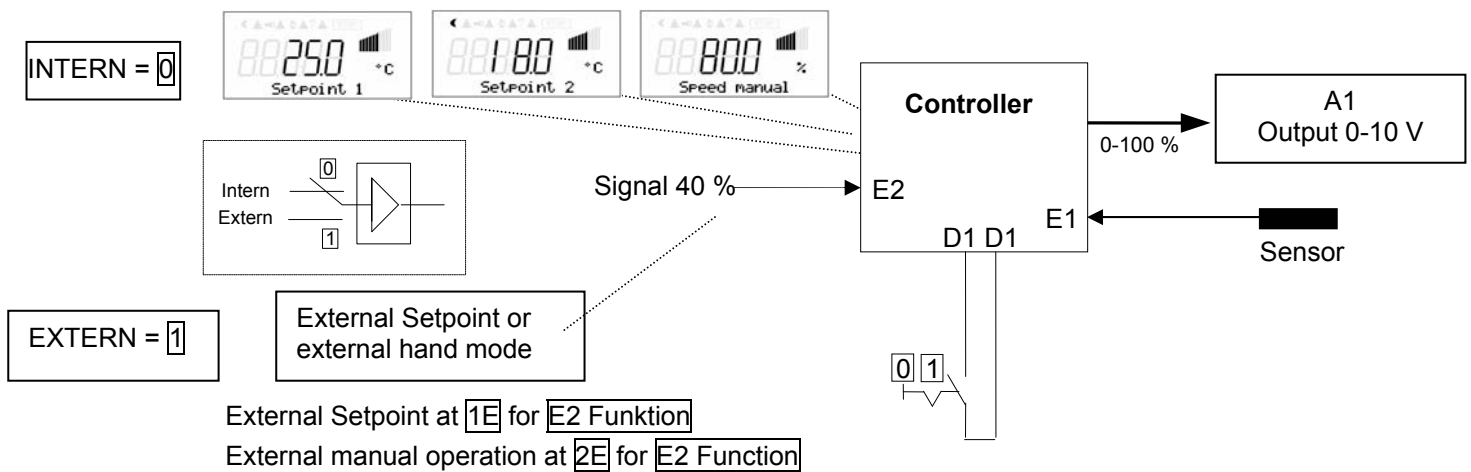


Set Intern 1 at opened kontakt ↔ Set Extern at closed contact **D1 Inverting** **OFF**

Set Intern 1 at closed kontakt ↔ Set Extern at opened contact **D1 Inverting** **ON**

◆ **Switch over between aktiv setting at the unit and external Signal** (for mode controller higher **2.01**)

Contact at digital input e. g. Digital IN 1 = D1-D1



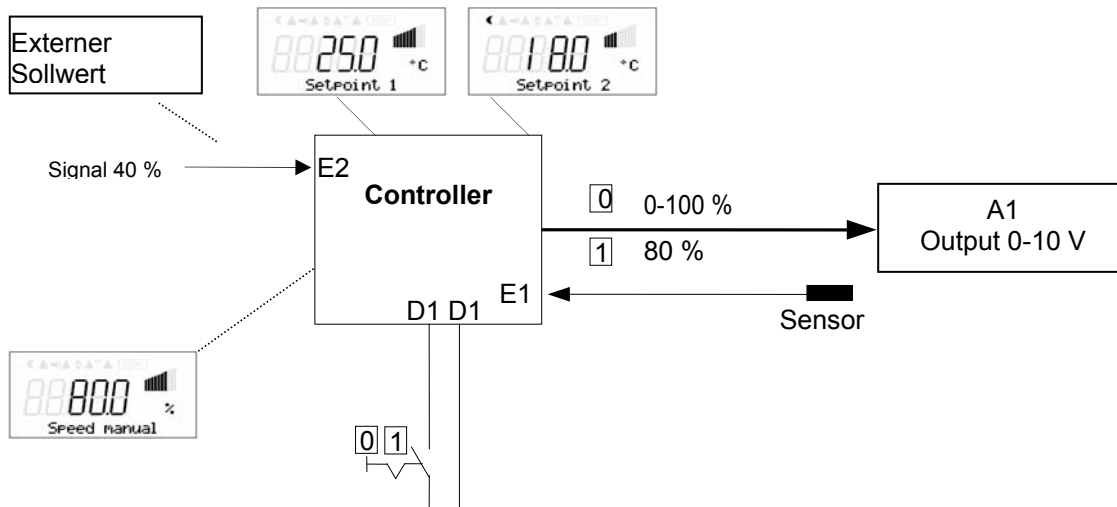
Setting at the unit at opened contact ↔ Signal Extern at closed contact **D1 Inverting** **OFF**

Setting at the unit at closed contact ↔ Signal Extern at opened contact **D1 Inverting** **ON**

13.2.7 Automatic control / speed manual internal (Menu Speed maunal) Funktion 7D

Switch over between automatic control to set target value (depending on the activation: Setpoint 1, Setpoint 2, Setpoint external) and the default for manual operation set at the device.

Contact at digital input e. g. Digital IN 1 = D1-D1



Automatic control at opened contact ↔ manual operation at closed contact

D1 Inverting OFF

Automatic control at closed contact ↔ manual operation at opened contact

D1 Invertierung ON

13.2.8 Reverse action of control function actual value>Set = n+ or actual value>Set = n- Funktion 8D

Switchover between: Increasing modulation during increasing actual-value and increasing modulation during sinking actual-value.

The factory presets for the “Control function“ are dependent on the selected mode of operation (☞ Controller Setup → reverse operation of the control function.)

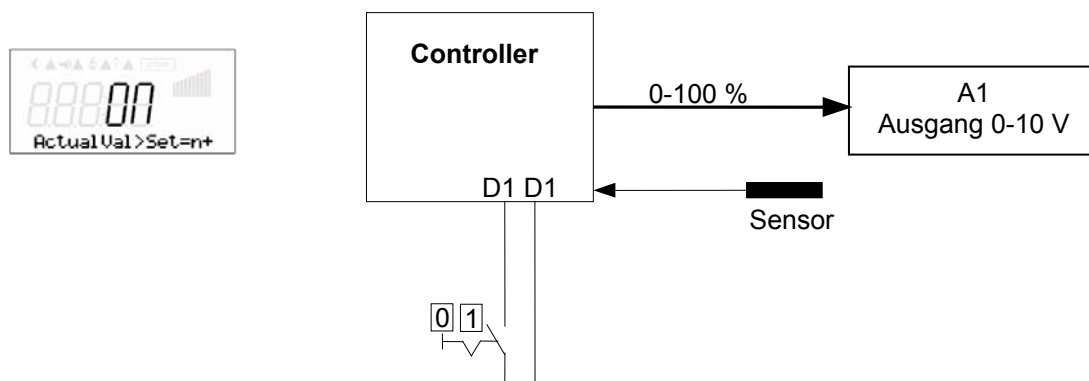
When switching over via a digital input, the device works with the opposite function than the one set there!

Example: Actual value>Set = n+ (increasing modulation during increasingg actual value)

kontakt at digital input e. g. Digital IN 1 = D1-D1

Setting in Controller Setup

kontakt at digital input e. g. Digital IN 1 = D1-D1



actual Value>Set = n+ at opened contact ↔ actual > Set = n- at closed kontakt

D1 Inverting OFF

actual Value>Set = n+ at closed contact ↔ actual > Setl = n- at opened contact

D1 Inverting ON

13.3 Inverting analog inputs E1 and E2

After programming the signal or sensor type, an inversion of the inputs can be carried out.



Factory setting for Inverting inputs = "OFF" (if input activated)
(signal: 0-10 V, 0-20 mA, 4-20 mA)

For activation using inverted default signals or sensors with inverted output signals proportional to the measurement range, switch inverting to "ON"
(Signal: 10-0 V, 20-0 mA, 20-4 mA)

Ziehl-Abegg sensors generally do not work with inverted output signals (i.e., these are not suitable for an inverted evaluation)

e. g.:

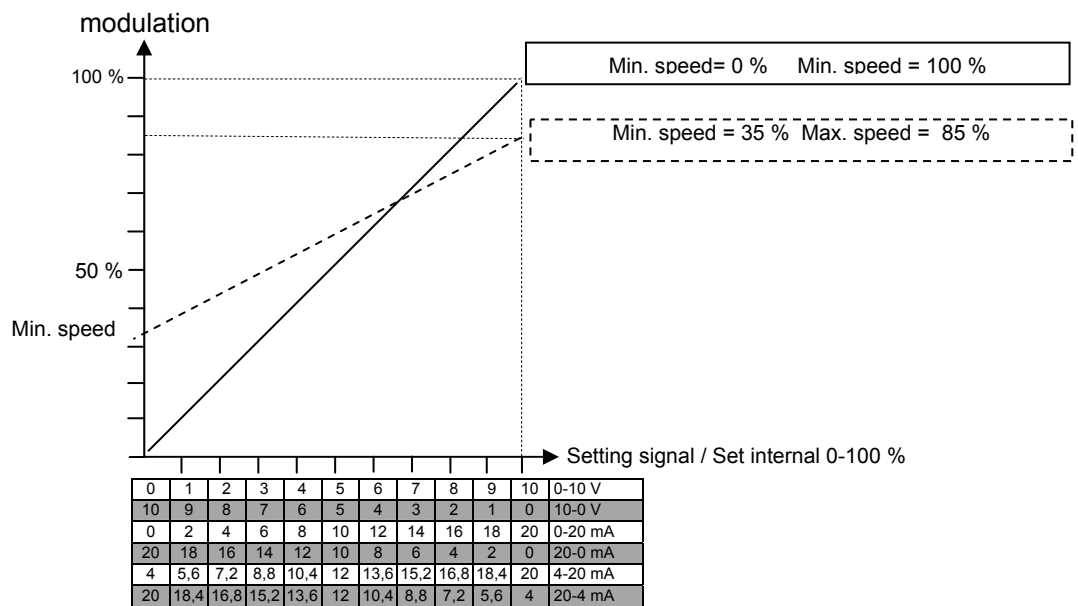
DSG200	0-10 V	proportional	0-200 Pa
MAL1	0-10 V	proportional	0-1 m/s
DSF2-25	4-20 mA	proportional	2-25 bar
MBG-30I	4-20 mA	proportional	0-30 bar

In sensors with inverted outputs, 0 V or 4 mA must correspond to the final value of the measurement range.

e. g. pressure sensor 10-0 V proportional 0-200 Pa

example:
mode **1.01** speed controller
setting by external signal

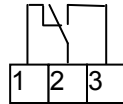
Inverting OFF
Inverting ON



Idealized principle diagram

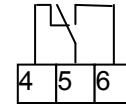
13.4 Function and inverting for relay outputs K1 and K2

Various functions can be allocated to the relay outputs K1 and K2
 In case of the same function allocation for K1 and K2, these work parallel.



K1

Max. contact rating
5 A / 250 V AC



K2

1 = de-energized, terminals 2-3 bridged
 0 = energized, terminals 1-2 bridged

1 = energized, bridged 5-6 bridged
 0 = de-energized, bridged 4-5 bridged



Function	description
--	no Function Relays remain always de-energized
1 K	Operating indication (factory setting for K1) Operation without fault, reports enable ON / OFF
2 K	Fault indication (factory setting for K2) At controller fault, Sensor fault dependent on programming, external fault at digital input
3 K	External fault separate With message at digital input (factory setting if terminals bridged)
4 K	Limit modulation when over or falling below limits for modulation
5 K	Limit E1 when over or falling below limits for input signal E1
6 K	Limit E2 when over or falling below limits for input signal E2
For modes as controller (higher 2.01)	
7 K	Setpoint Offset Deviation between actual value and setpoint to high
8 K	Group control Switching on fans depending on modulation
For modes as temperature controller with additional functions (2.03))	
9 K	Heating function Switch ON point: temperature = Setpoint +/- Offset Switch OFF point: Temperature around hysteresis <u>over</u> switch ON point
10 K	Cooling function Switch ON point: temperature = Setpoint +/- Offset Switch OFF point: Temperature around hysteresis <u>below</u> switch ON point

K1 / K2 Inverting

The factory preset is the inversion of relay K1 and K2 to „OFF“ (if a function has been programmed).
 Switch to „ON“ for inversion (switch-time response depends on the allocated function). Fundamentally, the relays can only become operative if the electronics' voltage supply is functioning.

Function	Controller status	K1 / K2 Inverting	
		OFF	ON
1 K	Operation without fault, line supply okay	1	0
2 K	Fault with indication by relay	0	1
3 K	Ext. Fault at digital input for external fault	1	0
4 K	when over or falling below limits for modulation	1	0
5 K	when over or falling below limits for input signal E1	1	0
6 K	when over or falling below limits for input signal E2	1	0
7 K	setpoint deviation to high	1	0
8 K	Switching on second group	1	0

13.5 Network for several devices by MODBUS

13.5.1 MODBUS - RTU (Remote terminal unit)

It is possible to network several devices with each other. .

The device uses the MODBUS-RTU as the protocol for the RS-485 interface. The communications parameters are permanently set to 19200 baud, 8 data bits, EVEN parity, 1 stopbit, (8E1).

A maximum of 247 stations can be connected with each other. The device address (Device-ID) is factory set to the highest available MODBUS address: **247**

This address is reserved for operation with an external terminal model A-XG.. and should not be occupied with anything else.

The addresses of the individual units must be continuously numbered beginning with „1“. No address may be allocated twice.

MODBUS address adjustable from 1-247

Address 247 = preprogrammed for an external terminal



When using an external AXG.. terminal, the interface is assigned and can not be employed for anything else

13.5.2 External display

The device uses MODBUS as the protocol for data exchange with an external AXG... display. During this, the external display is the MODBUS master. In this case, the interface is occupied and cannot be utilized for anything else.

The external display uses the **function code 105** (User Code) for the data exchange. This function code should therefore be avoided in a MODBUS system with other stations.

13.5.3 Reading and writing parameters

The device supports reading and writing processes for MODBUS Holding Registers (3). The start address is 1; the number of registers depends on the device. If the allowable start address or number is exceeded, the device answers with an exception code. The description of the register is device dependent and can be requested from Ziehl-Abegg service for the device/version concerned.

14. Limits

14.1 Limit indication depending on modulation

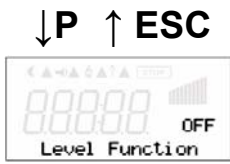


following functions can be allocated to the limit indication

Function	description
OFF	No function
1 L	Indication with the centralized fault of a programmed relay (IO allocation function 2K) warning symbol in display, "AL" code in events memory
2 L	Is merely displayed in the events menu as message "msg"

In the IO setup, a separate relay can be allocated independent of these settings.

If the modulation exceeds the set "Level max" value, this is reported until the set value "Level min" has been undercut. The indication is delayed by the time set in "Display delay".



Time delay exceeding "Level max." Up to indication by relay and alarm symbol.
 Factory setting 2 Seconds
 setting range 0-120 Seconds

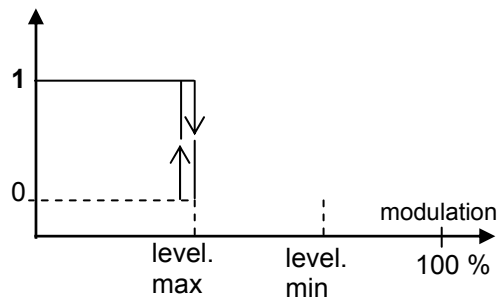
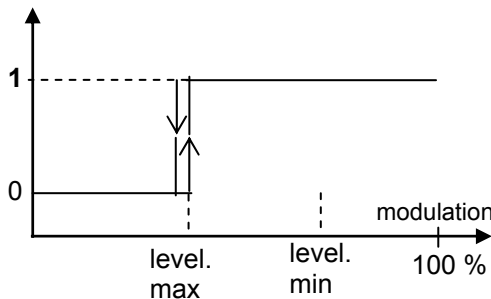
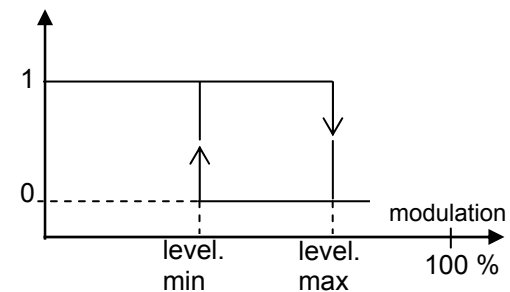
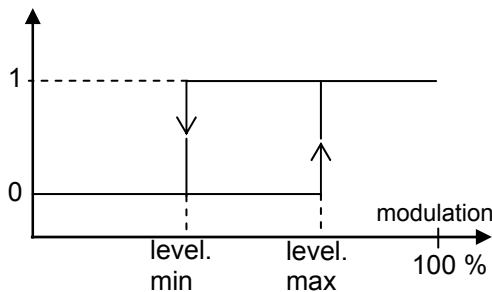
Example indication by relay K1:

not inverted

IO Setup → K1 Function: **4K**
 IO Setup → K1 Inverting: „OFF“

inverted

IO Setup → K1 Function: **4K**
 IO Setup → K1 Inverting: „ON“



If „Display min“ is **higher** than „Display max“, the „Display max.“ switching point is without hysteresis!

14.2 Limit indication depending on setting or sensor signal

following functions can be allocated to the limit indication:



Function	description
OFF	No function
1 L	Indication with the centralized fault of a programmed relay (IO allocation function 2K) warning symbol in display, "AL" code in events memory
2 L	Is merely displayed in the events menu as message "msg"

In the IO setup, a separate relay can be allocated independent of these settings

Both values for E1 („E1 min“ and „E1 max“) can be set independent of each other and act on a relay together if correspondingly programmed. If a function is activated or if a relay is allocated, both settings (min and max) are initially at OFF. Work can be carried out with one as well as with both limit indicators.

The same setting applies to E2 min and E2 max; described below for E1



Undercutting the signal („E1 min“)
If the signal undercuts the set value „E1 min“, this is reported until the set value (plus adjustable hysteresis) has been exceeded once again.



Exceeding the signal („E1 max“)
If the signal exceeds the set value „E1 max“, this is reported until the set value (minus hysteresis) has been undercut once again.



Hysteresis adjustment in the unit of measure of the programmed input signal



Time delay during alarms
Factory preset 2-seconds, adjustment range 0-120 seconds

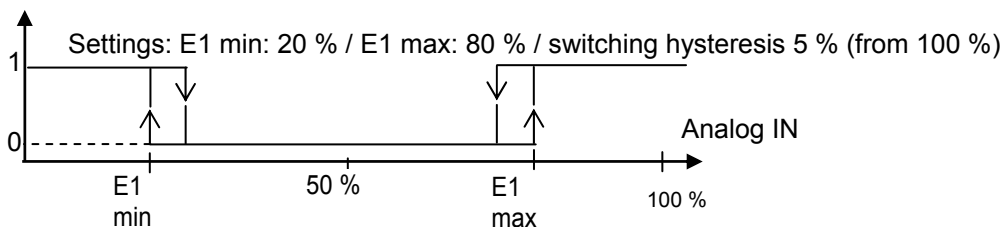
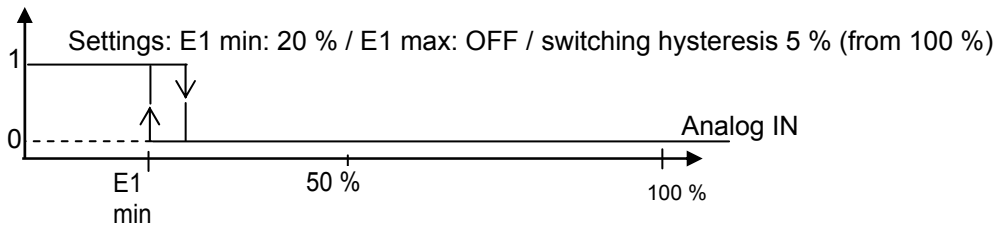
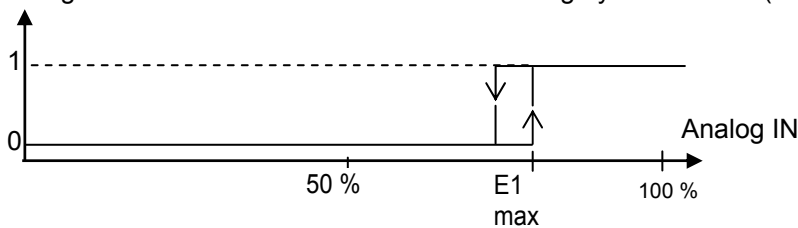


Always adjust the value for the maximum input signal higher than the value for the minimum input signal! E1 max. > E1 min!

Example for a limit indication of default signal or sensor signal to Analog IN 1

(Terminal E1 and GND) alarm via relay K1 (non-inverted) IO Setup → K1 function: „5 K“ = limit indicators E1

Settings: E1 max: 80 % / E1 min: OFF / switching hysteresis 5 % (from 100 %)



14.3 Limit indication depending on offset to Setpoint

In operating modes as a controller (via 2.01), two limit indicators can be carried out based on the set target value (Setpoint) and measured actual value (on E1).

The following functions can be allocated to this limit indicator



Function	Description
OFF	No function
1 L	Indication with the centralized fault of a programmed relay (IO allocation function 2K) warning symbol in display, "AL" code in events memory
2 L	Is merely displayed in the events menu as message "msg"

In the IO setup, a separate relay can be allocated independent of these settings.

Both values for Offset 1 and Offset 2 can be set independent of each other and act on a relay together if correspondingly programmed. If a function is activated or if a relay is allocated both settings (Offset 1 and Offset 2) are initially at OFF. Work can be carried out with one as well as with both limit indicators.



Offset 1 for alarm in case of an **exceeding of the max. deviation** between actual and target
 SwitchON point: actual value = Setpoint +/- offset
 SwitchOFF point: Actual value by hysteresis under the switch-on point.



Offset 2 for alarm in case of an **undercutting of the max. deviation** between actual and target
 SwitchON point: actual value = target value +/- offset
 SwitchOFF point: Actual value by hysteresis over the switch-on point.



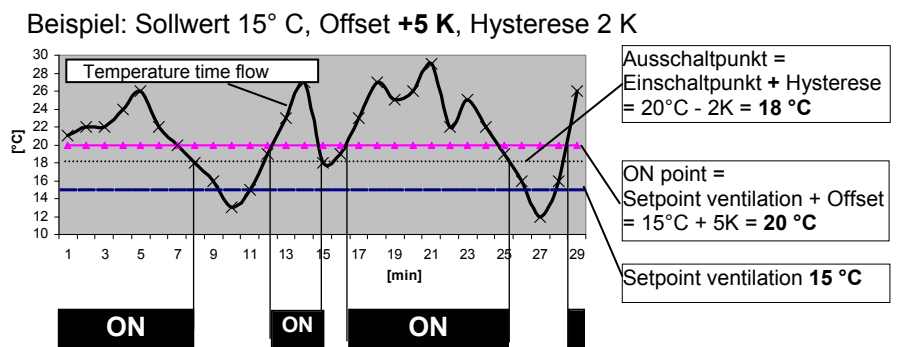
Hysteresis switch-on point: In temperature regulation ±10 K, otherwise sensors 10 % of measurement range.



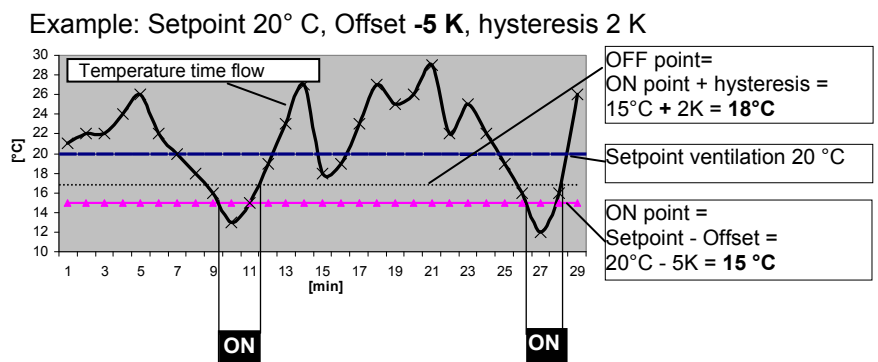
Time delay until indication through relay and alarm symbol. Factory preset 2 seconds, adjustment range 0-120 sec

Example for temperature regulation; for other modes of operation settings in corresponding sensor unit.

Offset 1 for alarm during exceeding



Offset 2 for alarm during undercutting



15. Timer (timer)

The device has a real-time clock. The clock is buffered and has a 2-3 day reserve. The time and date must be set during start-up operation and when using the real-time clock. The device calculates the weekday based on the date.

15.1 Setting the time and date

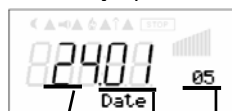


↓ P ↑ ESC



„Press the „P button“ and, using the UP and DOWN keys, set the hours. Press the „P button“ to save. The minutes indicator now flashes and can be set using the UP / DOWN keys. Press the „P button“ once more to conclude. The time has now been stored. This procedure only takes a moment. Afterwards, the new time appears in the display.

↓ ↑



To set the date follow the same method as for „Time“. The date setting consists of DAY, MONTH, and YEAR

day / month / year

15.2 Automatic summer/winter time

The automatic summer/winter time is factory set to „OFF“, i.e. switched off.

When the automatic summer/winter timer is set to = „ON“, the device automatically switches between daylight savings time and standard time.



Automatic swicht over between summer time and winter time

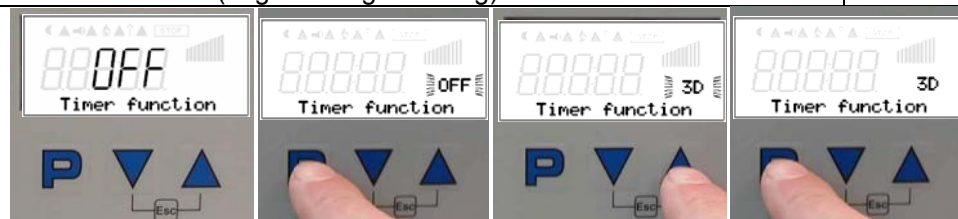
15.3 Timer function

In principle, the timer function acts like one digital switch input. Thus, the same functions can be assigned to the timer switch as the digital inputs, „D1“, „D2“..

A summary of the timer functions (example IO Setup / Function description 1D, 8D) then corresponds to Timer „On“ with function 1D a closed contact with function 2D, 8D a closed contact (OFF during inversion).

Function	description	Timer ON =
--	no function (factory setting)	
1 D	Enable (remote control) ON / OFF	Device OFF
2 D	External fault	fault
3 D	Limit ON / OFF Limitation of max. output voltage	Limit ON
4 D	E1 / E2 Switch over between signal at Analog IN 1 (E1) and Analog IN 2 (E2)	Signal at E2
For mode speed controller 1.01		
5 D	Set Intern 1 / 2 Switch over between 2 adjusted settings at the controller	Set intern 2
6 D	Intern / Extern Switch over setting at the controller / external signal	External signal
For modes as controller (higher 2.01)		
5 D	Setpoint 1 / 2 Switch over between 2 Setpoints (e. g. day- / night operation)	Setpoint 2
6 D	Intern / Extern Switch over between setting at the controller or external signal	External signal
7 D	switch over between automatic control and Speed manual	Setting manual
8 D	Switch over between ON: ActualVal>Set =n+ and OFF: Actual>Set=n- Reverse action of control function (e. g. Heating / Cooling)	Reverse Standard

Example:
Programming limitation for output voltage („Limit ON / OFF“)

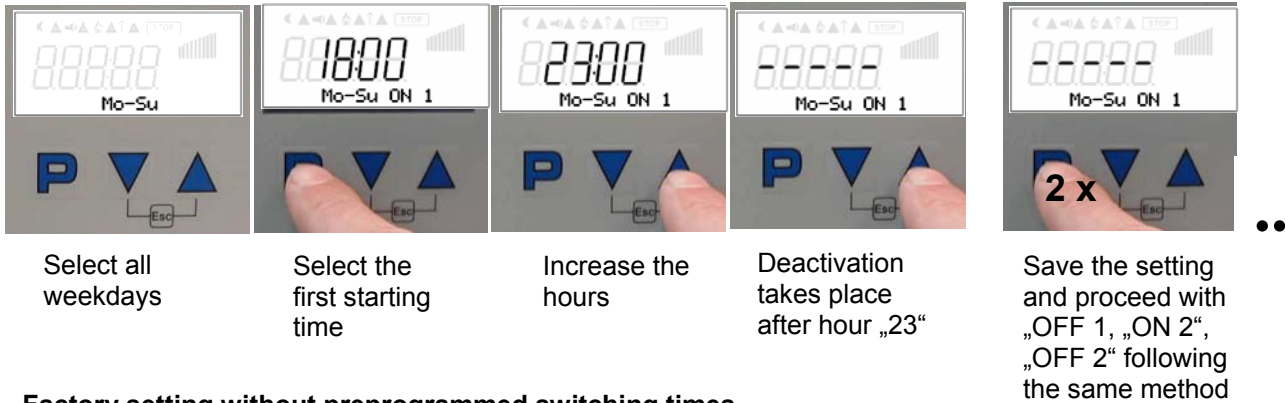


15.4 Enter switching times

Two switching times can be entered for the same function (e.g. 3D = Limit) for each weekday. The menu items are repeated for each weekday with two on- and off-times each. Switching times are not preprogrammed at the factory.

In order to make configuration easier, the same switching times can be made for several days in a block. To prevent unwanted switching times from arising, all should be deleted before programming. To do this, select the block **Mo - Su** and deactivate all 4 switching times.

Be sure to delete all switching times before carrying out complete new settings.



◆ Factory setting without preprogrammed switching times

Mo - Su													
Mo - Fr									Sa - Su				
Mo	Tu	We	Th	Fr	Sa	Su							
ON1	--:--	ON 1	--:--	ON 1	--:--	ON 1	--:--	ON 1	--:--	ON 1	--:--	ON 1	--:--
OFF1	--:--	OFF 1	--:--	OFF 1	--:--	OFF 1	--:--	OFF 1	--:--	OFF 1	--:--	OFF 1	--:--
ON 2	--:--	ON 2	--:--	ON 2	--:--	ON 2	--:--	ON 2	--:--	ON 2	--:--	ON2	--:--
OFF 2	--:--	OFF 2	--:--	OFF 2	--:--	OFF 2	--:--	OFF 2	--:--	OFF 2	--:--	OFF 2	--:--

◆ Example 1: Every day at 8 am ON and at 6 pm OFF

Mo - Su													
EIN1	08:00	EIN 1	08:00	EIN 1	08:00	EIN 1	08:00	EIN 1	08:00	EIN 1	08:00	EIN 1	08:00
OFF1	18:00	OFF1	18:00	OFF1	18:00	OFF1	18:00	OFF1	18:00	OFF1	18:00	OFF1	18:00
ON 2	--:--	ON 2	--:--	ON 2	--:--	ON 2	--:--	ON 2	--:--	ON 2	--:--	ON 2	--:--
OFF2	--:--	OFF2	--:--	OFF2	--:--	OFF2	--:--	OFF2	--:--	OFF2	--:--	OFF2	--:--

◆ Example 2: Monday to Friday at 6 am ON at 8 am OFF and at 5 pm ON at 10 pm OFF

Mo - Fr									Sa - Su				
ON1	06:00	ON1	06:00	ON1	06:00	ON1	06:00	ON1	06:00	ON1	--:--	ON1	--:--
OFF1	08:00	OFF1	08:00	OFF1	08:00	OFF1	08:00	OFF1	08:00	OFF1	--:--	OFF1	--:--
ON2	17:00	ON2	17:00	ON2	17:00	ON2	17:00	ON2	17:00	ON2	--:--	ON2	--:--
OFF2	22:00	OFF2	22:00	OFF2	22:00	OFF2	22:00	OFF2	22:00	OFF2	--:--	OFF2	--:--

◆ Example 3: Wednesday 6 pm ON and Thursday at 8 am OFF

Mo	Tu	We	Th	Fr	Sa	Su							
ON1	--:--	ON1	18:00	ON1	--:--	ON1	--:--	ON1	--:--	ON1	--:--	ON1	--:--
OFF1	--:--	OFF1	--:--	OFF1	08:00	OFF1	--:--	OFF1	--:--	OFF1	--:--	OFF1	--:--
ON2	--:--	ON2	--:--	ON2	--:--	ON2	--:--	ON2	--:--	ON2	--:--	ON2	--:--
OFF2	--:--	OFF2	--:--	OFF2	--:--	OFF2	--:--	OFF2	--:--	OFF2	--:--	OFF2	--:--

◆ Free tables for entering individual timer settings

Mo	Tu	We	Th	Fr	Sa	Su							
ON1		ON1		ON1		ON1		ON1		ON1		ON1	
OFF1		OFF1		OFF1		OFF1		OFF1		OFF1		OFF1	
ON2		ON2		ON2		ON2		ON2		ON2		ON2	
OFF2		OFF2		OFF2		OFF2		OFF2		OFF2		OFF2	

16. Diagnostics menu



The diagnostics menu supplies information about the momentary operating condition of the device. Under certain circumstances, conclusions can be drawn about possible malfunctions through these insights..



Operation hours counter for Controller.
The time counting runs, as soon as mains voltage is connected (without fault). If events step on (motor fault, external fault, etc.), the period of operation is stored at this time.



Operation hours counter for motor.
The time counting runs as soon as a modulation of the controller is present.



Signal height at analog input E1 (Analog IN 1)



Signal height at analog input E2 (Analog IN 2)



Status digital input 1 (Digital IN 1)
OFF = terminals D1- D1 bridged ↔ ON = terminals D1-D1 not bridged



Status digital input 2 (Digital IN 2)
OFF = terminals D2- D2 bridged ↔ ON = terminals D2-D2 not bridged



Status digital input (Digital IN 3)
OFF = terminals D3- D3 bridged ↔ ON = terminals D3-D3 not bridged



Status digital input 4 (Digital IN 4)
OFF = terminals D4- D4 bridged ↔ ON = terminals D4-D4 nicht gebrückt



Status digital input 5 (Digital IN 5)
OFF = terminals D5- D5 bridged ↔ ON = terminals D5-D5 nicht gebrückt



Status timer function



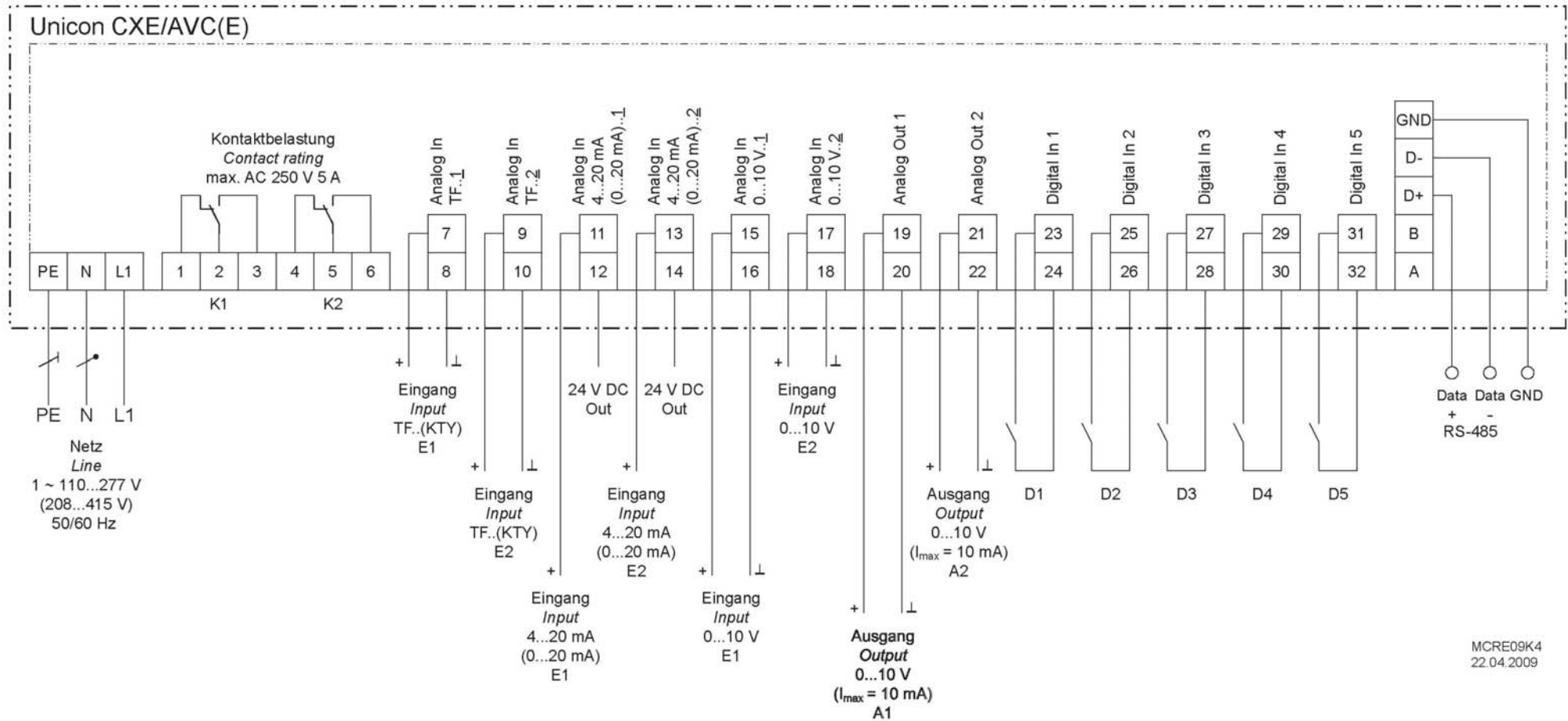
OFF = relay K1 de-energized terminals 1-2 bridged
ON = relay K1 energized = terminals 2-3 bridged



OFF = relay K2 de-energized terminals 4-5 bridged
ON = relay K2 energized = terminals 5-6 bridged

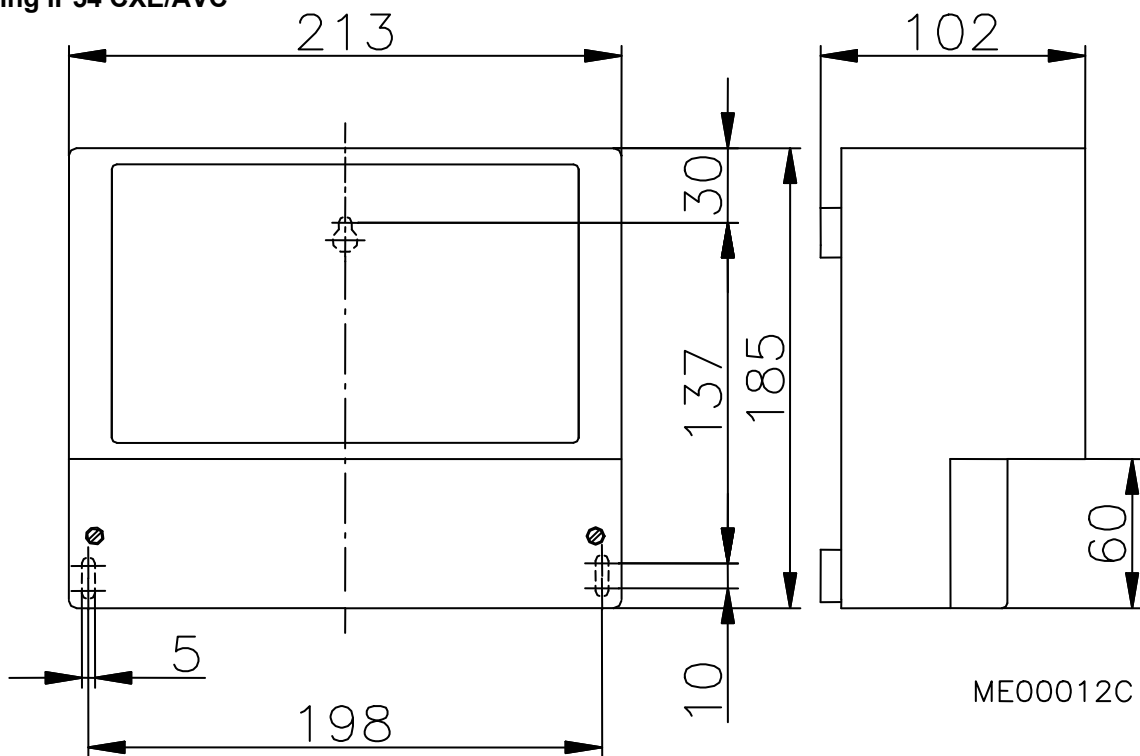
17. Enclosure

17.1 Connection diagram

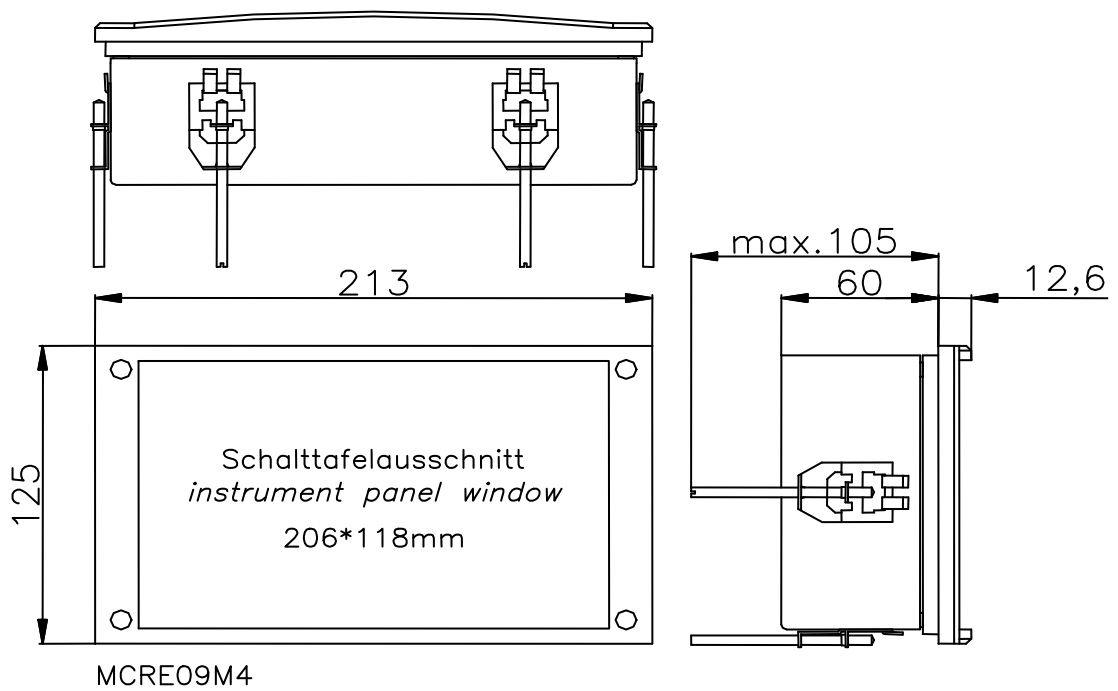


17.2 Dimension sheet

Wall housing IP54 CXE/AVC



Installation into control panel CXE/AVCE



18. Events



The last 10 (0-9) events and malfunctions are stored in the „Events“ menu group (position „0“ = most recent event).

The device differentiates between 3 types of events:

1. Messages with code **Msg**

Message sensor fault for information if “Alarm Sensor” deactivated.

2. Alarms with code **AL**

Events during which the device automatically restarts operation or remains in operation after the cause of the malfunction has been remedied (e.g. externally-trunked centralized fault).

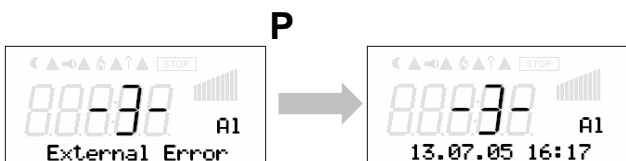
A momentary pending alarm or error message is indicated by a blinking indicator and appears alternately with the standard display.

Possible events and faults:

- **Factory setting** **Msg**
Fault in Eprom
controller works with defaults
- **Externe fault** **AL**
Motor protection unit triggered (signal contact at digital input)
- **EEP Error** **AL**
fault EEP EEP damaged
controller works with defaults
- **EEP Corruption** **AL**
data incorrectly. Controller runs with the read settings

With the "P" key can be switched between description of the message and the time when it happened.
E.G. on place 3 which is past message "motor fault"

Inquiry of the CONTROLLERS period of operation at the time of the message.



19. Messages and trouble shooting

A momentary pending alarm or error message is indicated by a blinking indicator and appears alternately with the standard display. In addition, it is signaled via the 3-internal LED's.



No Display

- line voltage available ? Unit switches OFF and automatically ON when the voltage has been restored
- check internal controller fuse)



Sensor fault

Interruption / short circuit in the sensor leads or sensor values measured are outside measuring range.
(Controller setup Alarm Sensors = ON)



NO enable

Switch OFF by external contact
(function 1D = enable programmed for Digital IN1/2)



External fault

Alarm from external contact (e.g. motor protection unit STDT with auxiliary contact)



Limit indication actual minimum

Actual value below setting “Alarm Minimum”
(Input E1)



Limit indication actual maximum

Actual value above setting “Alarm Maximum”
(Input E1)

20. Index

A	
Address	54
Air velocity control	36
Analog Output	44
Ausgang 0-10 V	44
Automatic summer/winter time	58
Average calculation	17
C	
Connection diagram	61
connection for input signal	10
control function	42
controller action	43
Controller Setup	40
controller type	43
Cooling	20
cooling function	18
D	
Date	58
Datenbus	9
D-component	43
Diagnostic	60
difference temperature	17
digital inputs	46
Dimension sheet	62
E	
Enable	47
Enter switching times	59
Events	63
External setpoint	10
H	
Heating	20
heating function	18
I	
I-component	43
input resistance	6
Integration time	43
isolation	47
K	
K-Factor	32
L	
Limit	41
Limit	48
Limits	55
M	
MAL1/10	36
Menu group Info	39
Menu group Start	39
Messages	63
Minimum speed cut off	41
MODBUS	9
Mode	11
mode of operation	11
N	
Network	54
O	
Outdoor installation	7
Output 0-10 V	44
P	
P-component	43
PID	43
PIN	39
PIN-Protection	40
Pressure Control Air Conditioning	28
Pressure control for condensers	24
Programming	14
R	
refrigerant	24
Relay outputs	53
Reset	39
Reverse	42
RS-485	9
S	
save user settings	40
Second group	42
Sensor Alarm ON / OFF	41
sensor cable	8
Set Intern 2	49
Set protection	40
Setpoint 2	49
Setup	44
Signal connection	8
Speed controller	14
speed reduction	48
T	
Technical data	6
Temperature control	16
Time	58
Timer	58
Timer function	58
Trouble shooting	63
Two-wire-technology	8
V	
volume control	32